

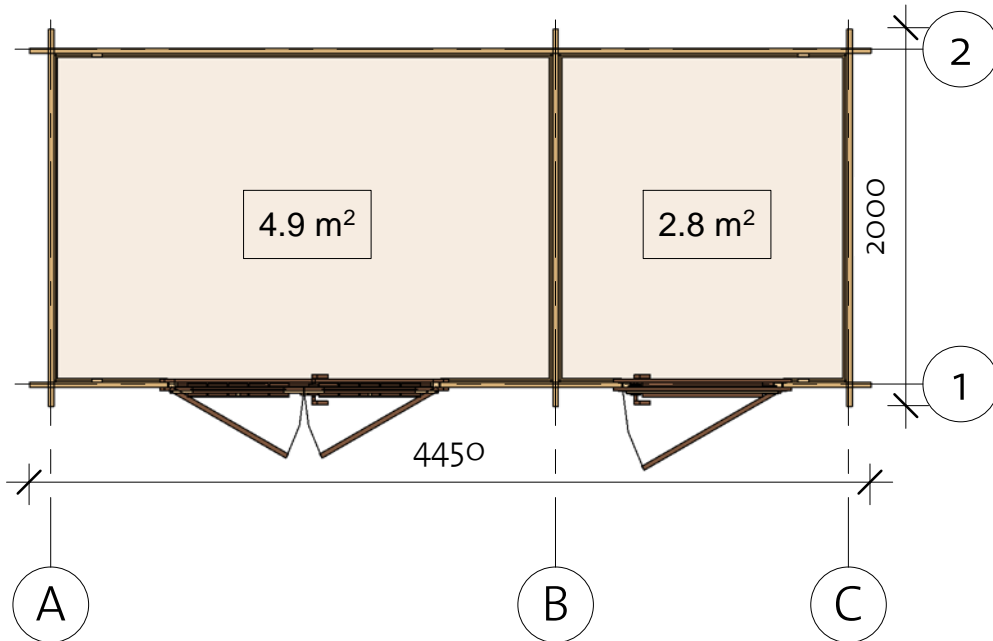

# Annika II 28 (425x180)

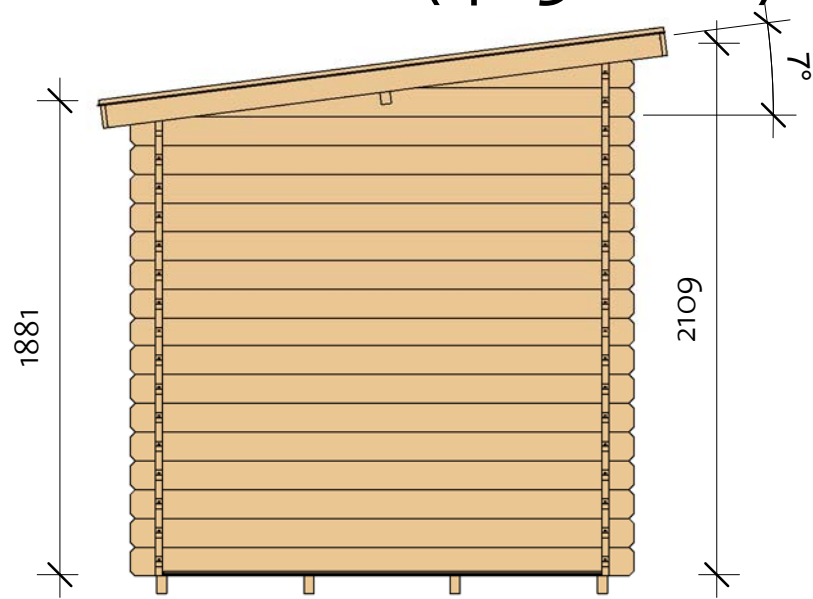

4000003\_190219

# Annika II 28 (425x180)

Foundation

Impregnated foundation beams				
Mark	Type	Profile	Length	Count
IFB	IFB 40x70		4240	4

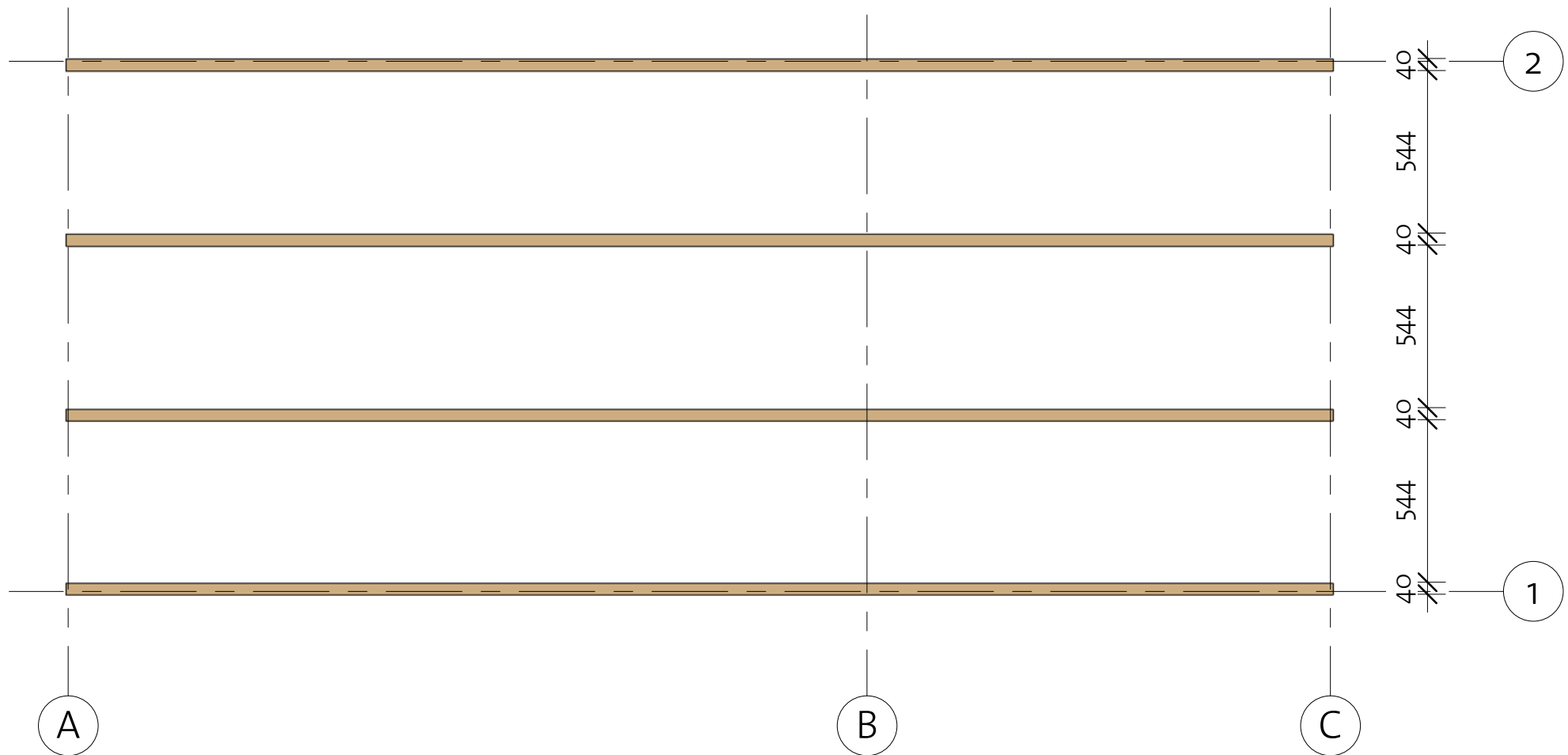



4000003\_190219

# Annika II 28 (425x180)

Floor Plan

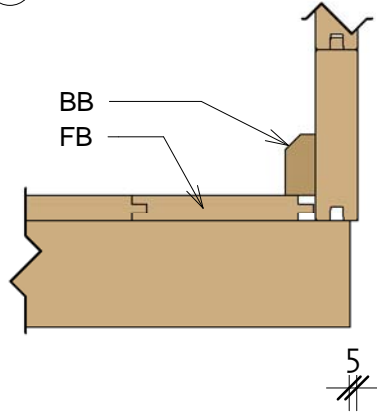
① Baseboard



Floor Schedule				
Mark	Type	Profile	Count	Length
FB	FB 18x110		39	1740
BB	BB 20x40		6	1800
BB	BB 20x40		2	2800

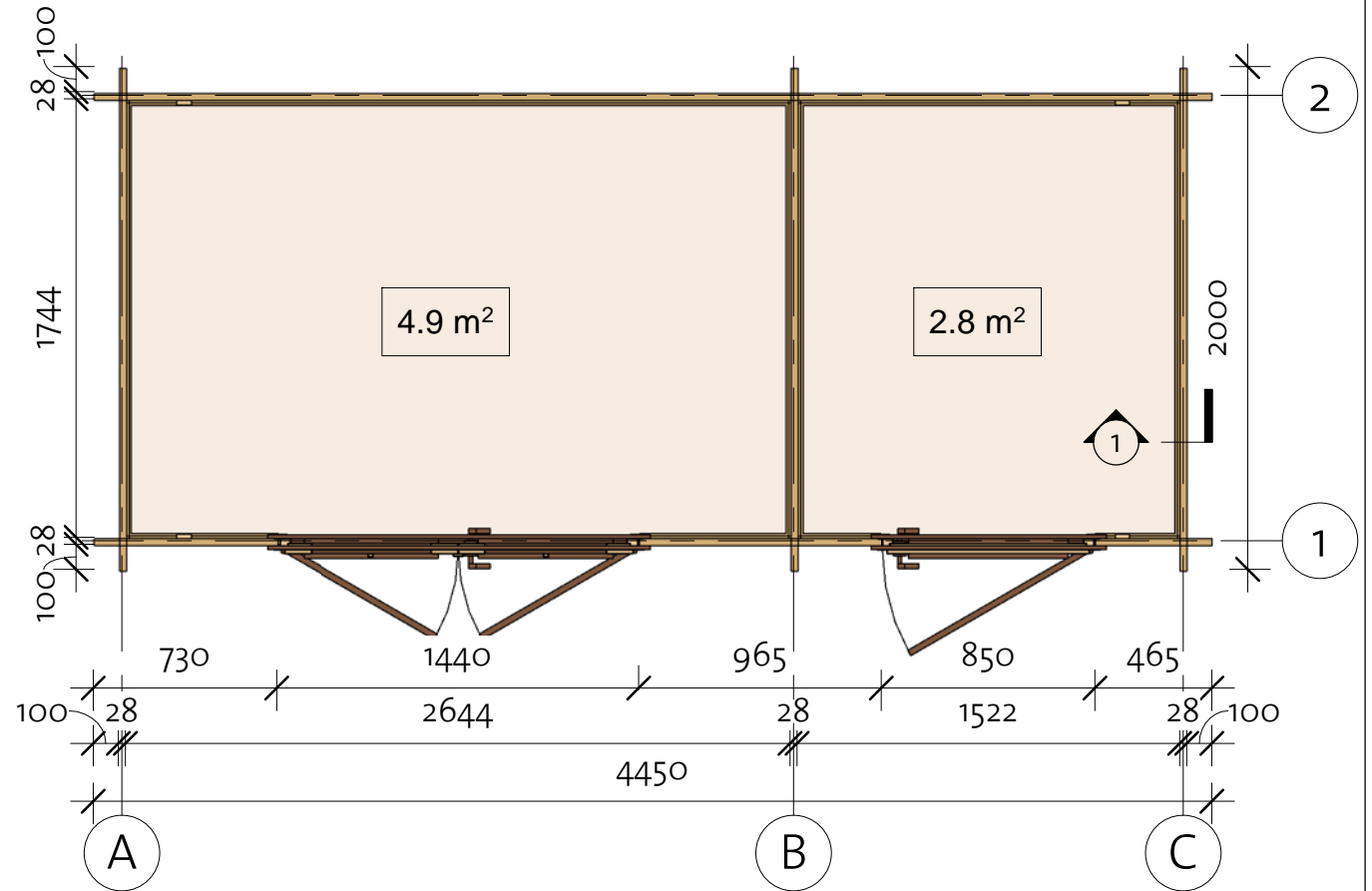

4000003\_190219

# Annika II 28 (425x180)

Wall 1

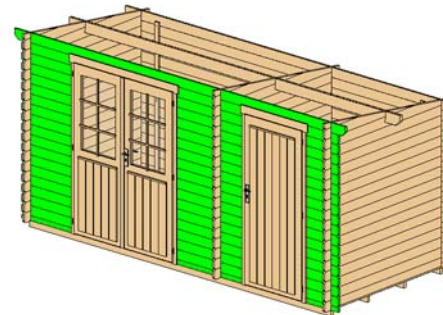

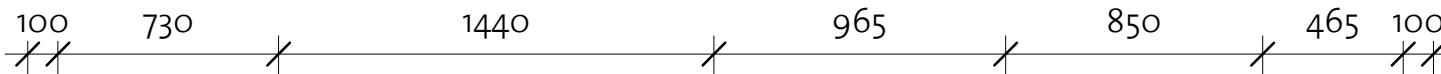
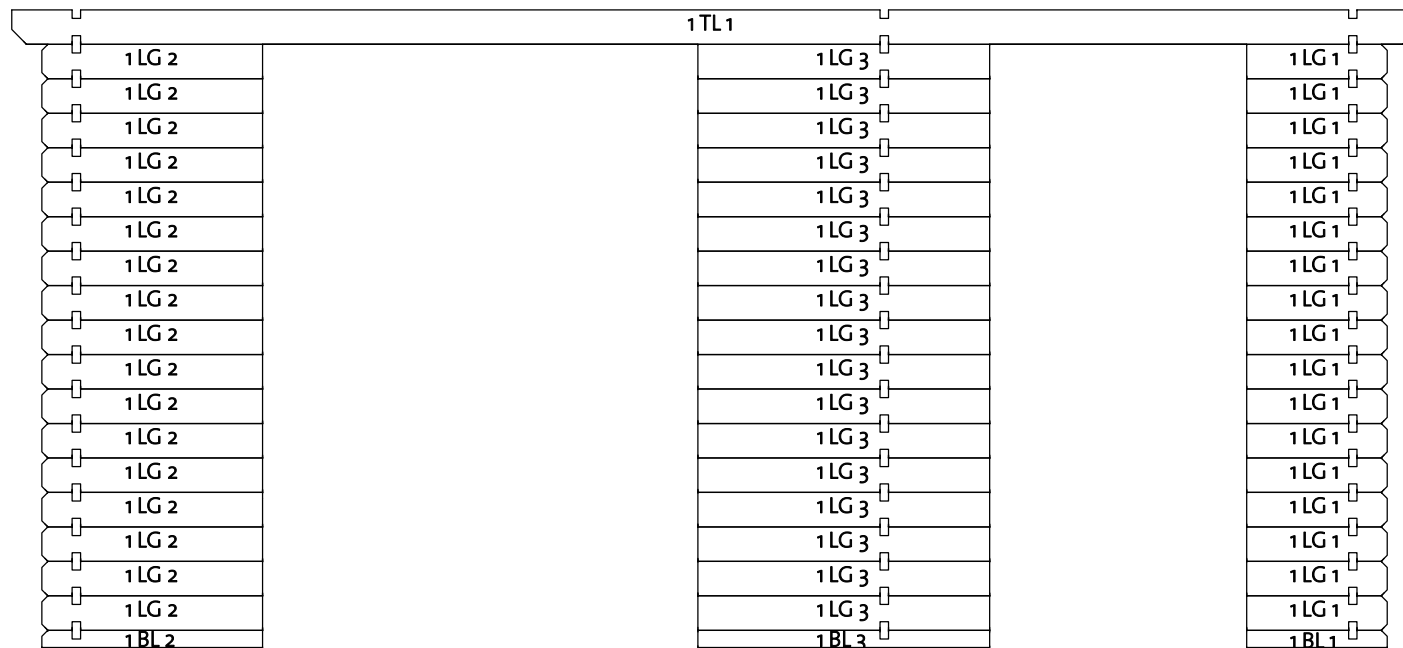

Wall 1			
Mark	Profile	Count	Cut Length

1BL 1	28x57	1	465
1BL 2	28x57	1	730
1BL 3	28x57	1	965
1LG 1	28x114	17	465
1LG 2	28x114	17	730
1LG 3	28x114	17	965
1TL 1	28x114	1	4650



Log Profile Wall 1	
Profile	Profile

28x57	
28x114	
28x114	

# Annika II 28 (425x180)

Wall 2

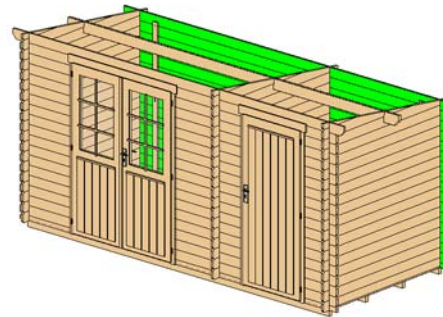

Wall 2			
Mark	Profile	Count	Cut Length

2BL 1	28x57	1	4450
2LG 1	28x114	15	4450
2TL 1	28x114	1	4650

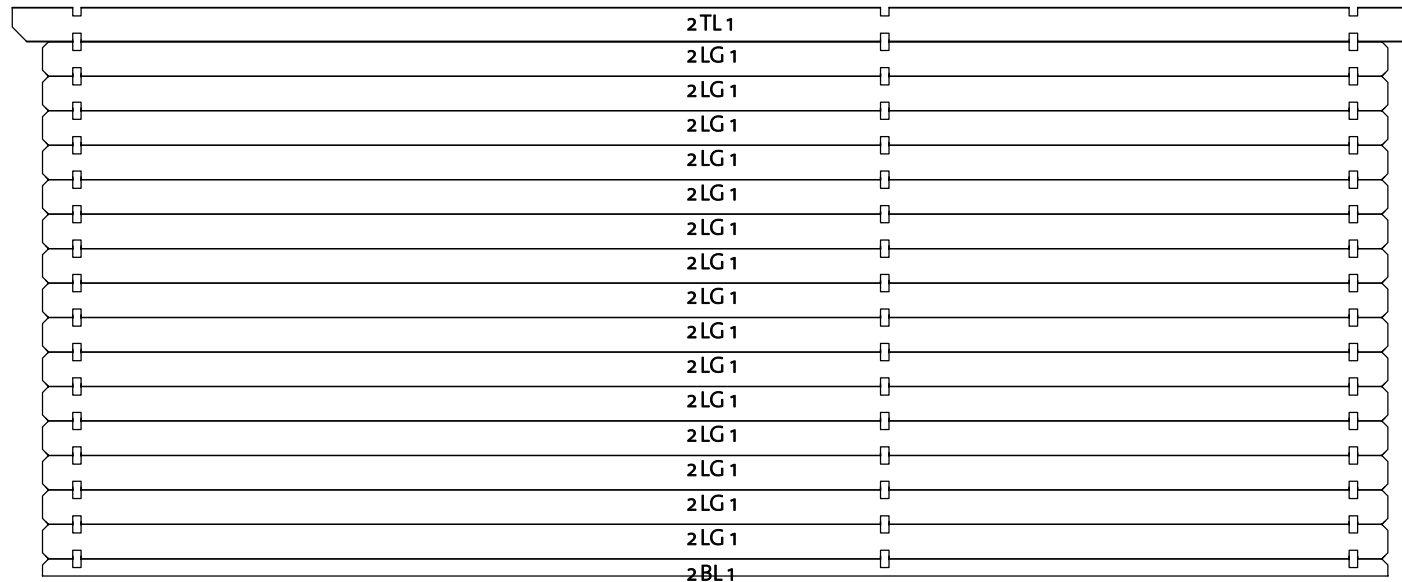

100  
//

4450

100  
//

Log Profile Wall 2	
Profile	Profile

28x57	
28x114	
28x114	

# Annika II 28 (425x180)

Wall A

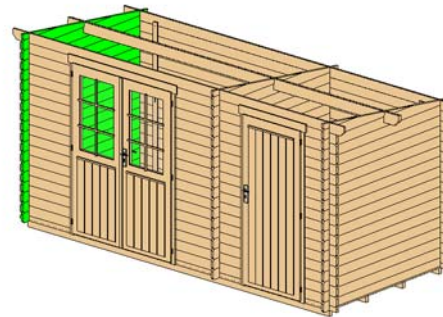

Wall A			
Mark	Profile	Count	Cut Length

ALG 1	28x114	1	543
ALG 2	28x114	1	1429
ALG 3	28x114	1	2000
ALG 4	28x114	16	2000

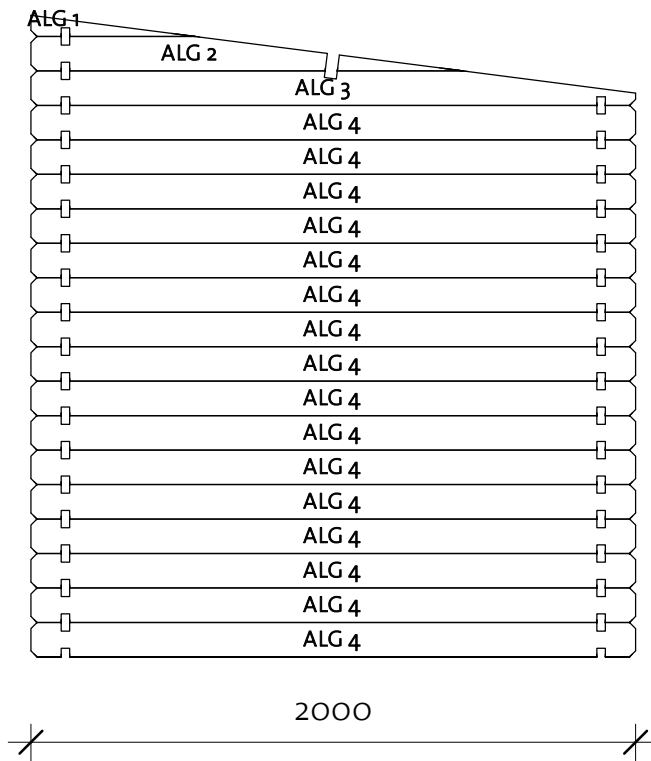

Log Profile Wall A	
Profile	Profile

28x114	
--------	---

# Annika II 28 (425x180)

Wall B

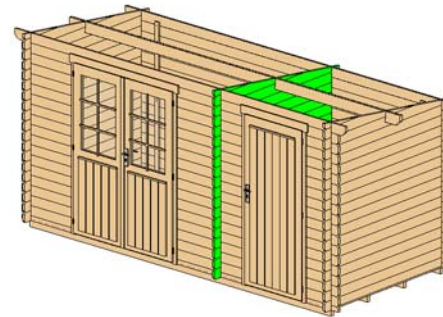

Wall B			
Mark	Profile	Count	Cut Length

BLG 1	28x114	1	543
BLG 2	28x114	1	1429
BLG 3	28x114	1	2000
BLG 4	28x114	16	2000

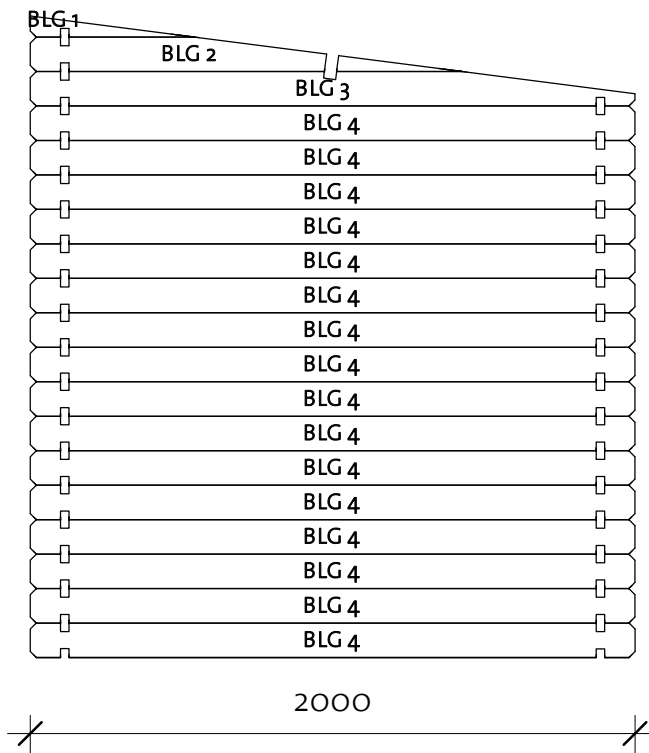

Log Profile Wall B	
Profile	Profile

28x114	
--------	---

# Annika II 28 (425x180)

Wall C

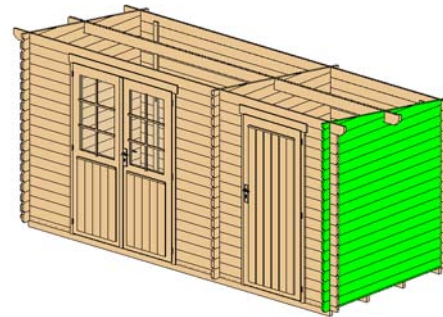

Wall C			
Mark	Profile	Count	Cut Length

CLG 1	28x114	1	543
CLG 2	28x114	1	1429
CLG 3	28x114	1	2000
CLG 4	28x114	16	2000

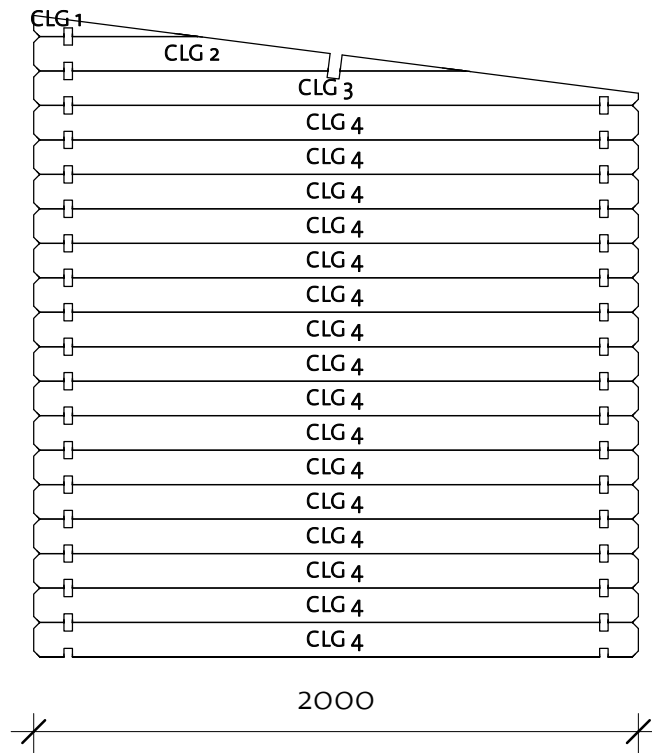

Log Profile Wall C	
Profile	Profile

28x114	
--------	---



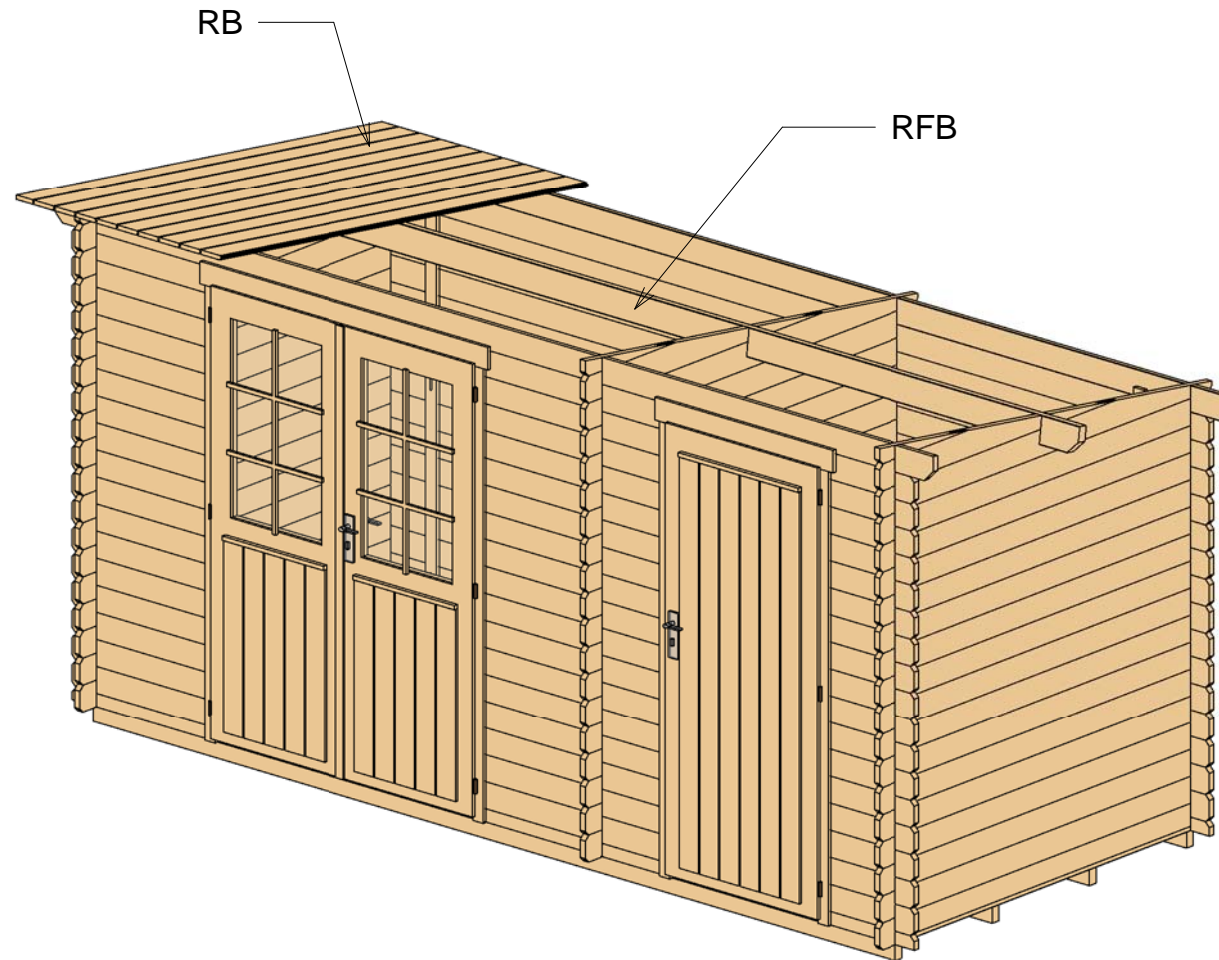

# Annika II 28 (425x180)

Roof 1



Roof				
Mark	Type	Profile	Count	Length

RFB	Beam 40x120		1	4650
RB	RoofBoard 18x110		44	2220

# Annika II 28 (425x180)

Roof 2

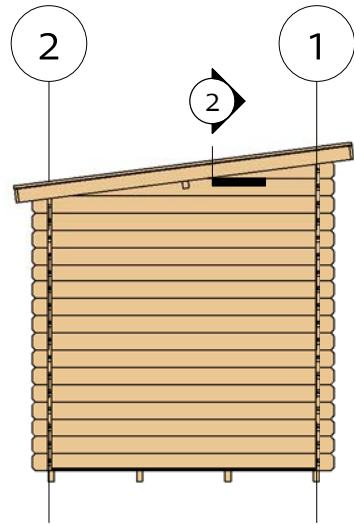

② Facia

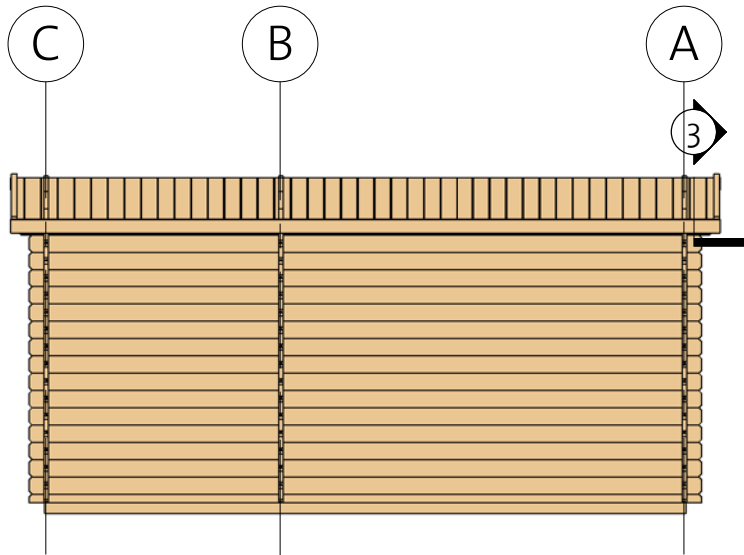
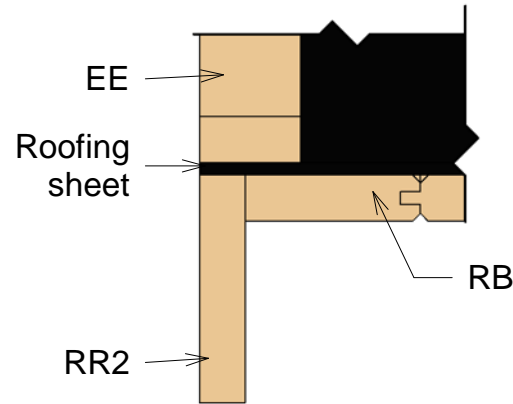

③ Roof Reinforcement

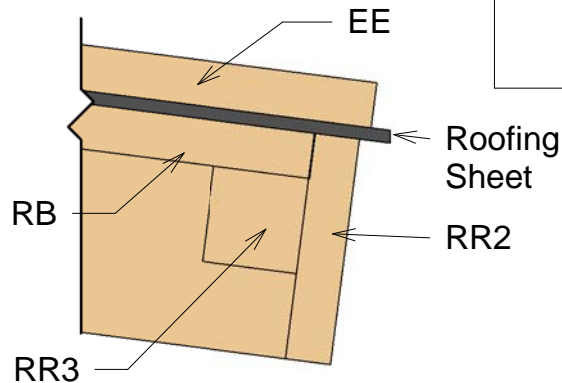

Fascia Schedule				
Mark	Type	Profile	Count	Length
EE	Eave Edging 18x40		2	2260
RR1	Roof reinforcement 18x90		2	4690
RR2	Roof reinforcement 18x90		2	2220
RR3	Roof reinforcement 38x38		2	4650

# Annika II 28 (425x180)

Extras



Door Schedule				
Model	Type	Width	Height	Count
BDD1R	Basic double door 1 right	1425	1955	1
BD2R	Basic door 2, wood right	840	1955	1
DCB6	Door crossbar 6	--	--	2

Fasteners/Extras		
Name	Comments	Count

Hitblock	300-400 mm	
Bolts	M8 x 60	12
Screws	5,0 x 70	15
Screws	6,0 x 140	30
Nails	1,4 x 40	35
Screws	4,0 x 40	70
Screws	4,0 x 50	320

4000003\_190219

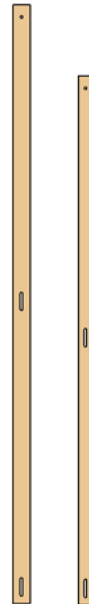

Windboard		
Family	Count	Length
Windboard 18x38	2	1750
Windboard 18x38	2	1980

# Annika II 28 (425x180)

## List of all items 1

### Impregnated foundation beams

Mark	Type	Profile	Length	Count
------	------	---------	--------	-------

IFB	IFB 40x70		4240	4
-----	--------------	---	------	---

### Floor Schedule

Mark	Type	Profile	Count	Length
------	------	---------	-------	--------



FB	FB 18x110		39	1740
----	-----------	---	----	------

BB	BB 20x40		6	1800
----	-------------	---	---	------

BB	BB 20x40		2	2800
----	-------------	--	---	------

### Roof

Mark	Type	Profile	Count	Length
------	------	---------	-------	--------

RFB	Beam 40x120		1	4650
RB	RoofBoard 18x110		44	2220

### Fascia Schedule

Mark	Type	Profile	Count	Length
------	------	---------	-------	--------

EE	Eave Edging 18x40		2	2260
----	----------------------	---	---	------

RR1	Roof reinforcement 18x90		2	4690
-----	--------------------------------	---	---	------

RR2	Roof reinforcement 18x90		2	2220
-----	--------------------------------	---	---	------

RR3	Roof reinforcement 38x38		2	4650
-----	--------------------------------	---	---	------

# Annika II 28 (425x180)

## List of all items 2



Wall 1			
Mark	Profile	Count	Cut Length

1BL 1	28x57	1	465
1BL 2	28x57	1	730
1BL 3	28x57	1	965
1LG 1	28x114	17	465
1LG 2	28x114	17	730
1LG 3	28x114	17	965
1TL 1	28x114	1	4650

Wall 2			
Mark	Profile	Count	Cut Length

2BL 1	28x57	1	4450
2LG 1	28x114	15	4450
2TL 1	28x114	1	4650

Log Profiles	
Profile	Profile

28x57	
28x114	
28x114	

Wall A			
Mark	Profile	Count	Cut Length

ALG 1	28x114	1	543
ALG 2	28x114	1	1429
ALG 3	28x114	1	2000
ALG 4	28x114	16	2000

Wall B			
Mark	Profile	Count	Cut Length

BLG 1	28x114	1	543
BLG 2	28x114	1	1429
BLG 3	28x114	1	2000
BLG 4	28x114	16	2000

Wall C			
Mark	Profile	Count	Cut Length

CLG 1	28x114	1	543
CLG 2	28x114	1	1429
CLG 3	28x114	1	2000
CLG 4	28x114	16	2000