

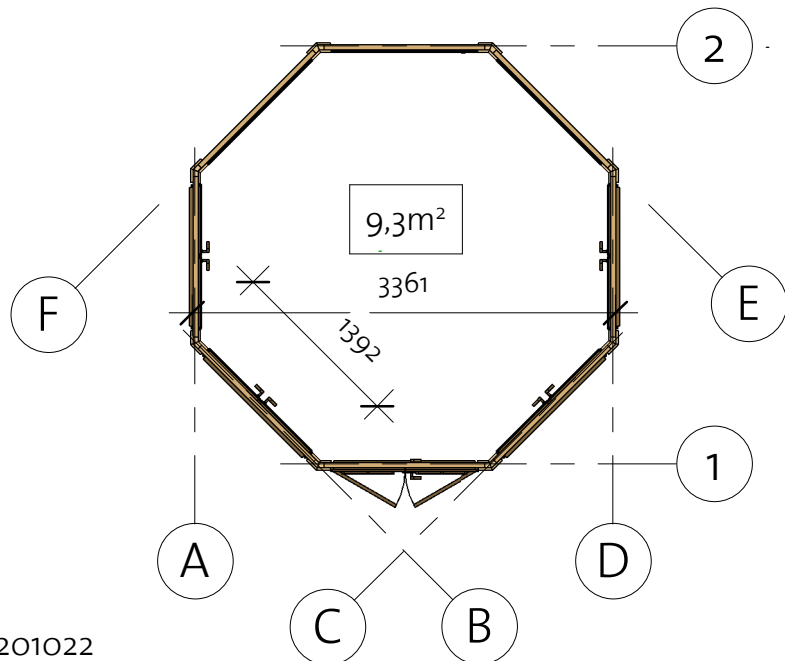

# Askersund 40 (336x336)

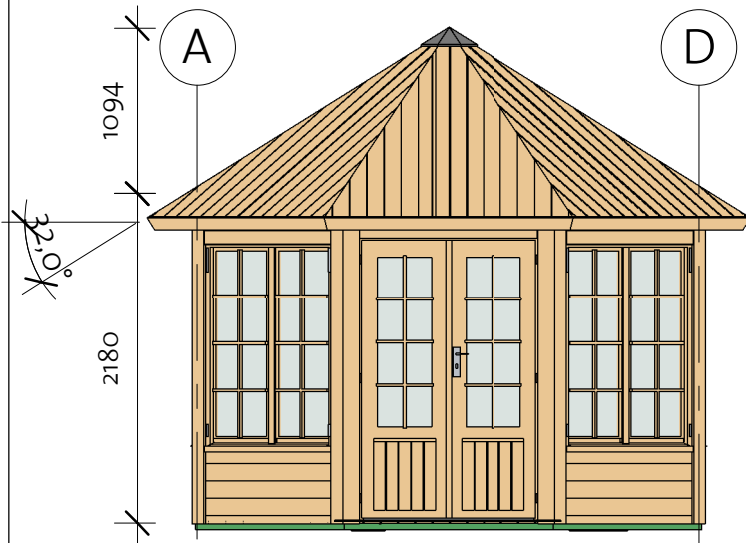

# Askersund 40 (336x336)

Floor Plan

Floor Schedule				
Mark	Type	Profile	Count	Length

FB11	FB 17x114		2	1675
FB12	FB 17x114		2	1561
FB13	FB 17x114		2	1447
FB14	FB 17x114		2	1333
FB15	FB 17x114		2	1219
FB16	FB 17x114		2	1105
FB17	FB 17x114		2	991
FB18	FB 17x114		2	877
FB19	FB 17x114		2	763

Floor elements		
Name	Type	Count

FE1	Floor element 1	1
FE2	Floor element 2	1
FE3	Floor element 3	2

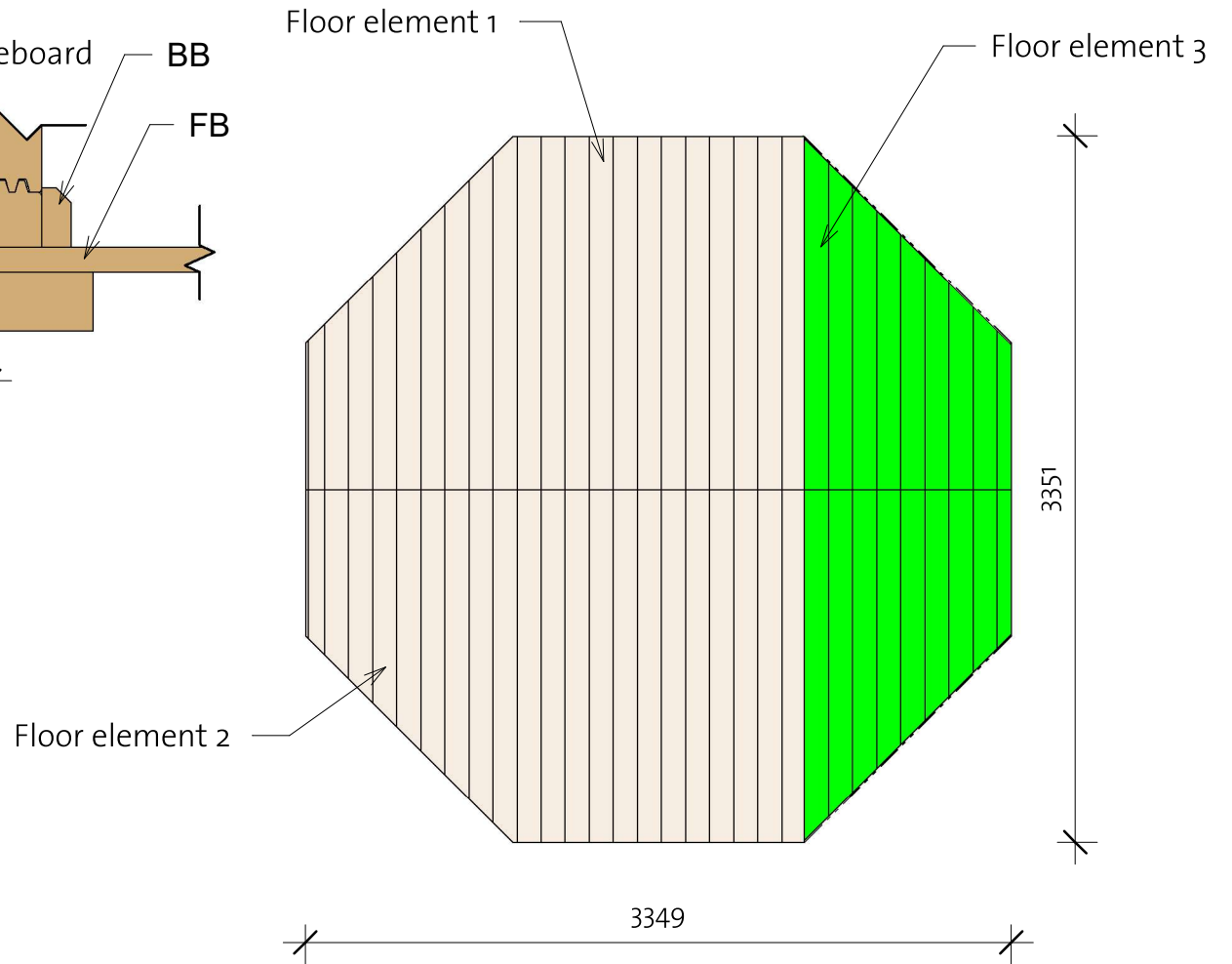
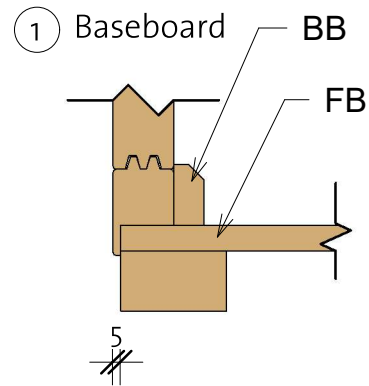

BB	BB 20x40		7	1169
----	----------	---	---	------

# Askersund 40 (336x336)

Wall 1

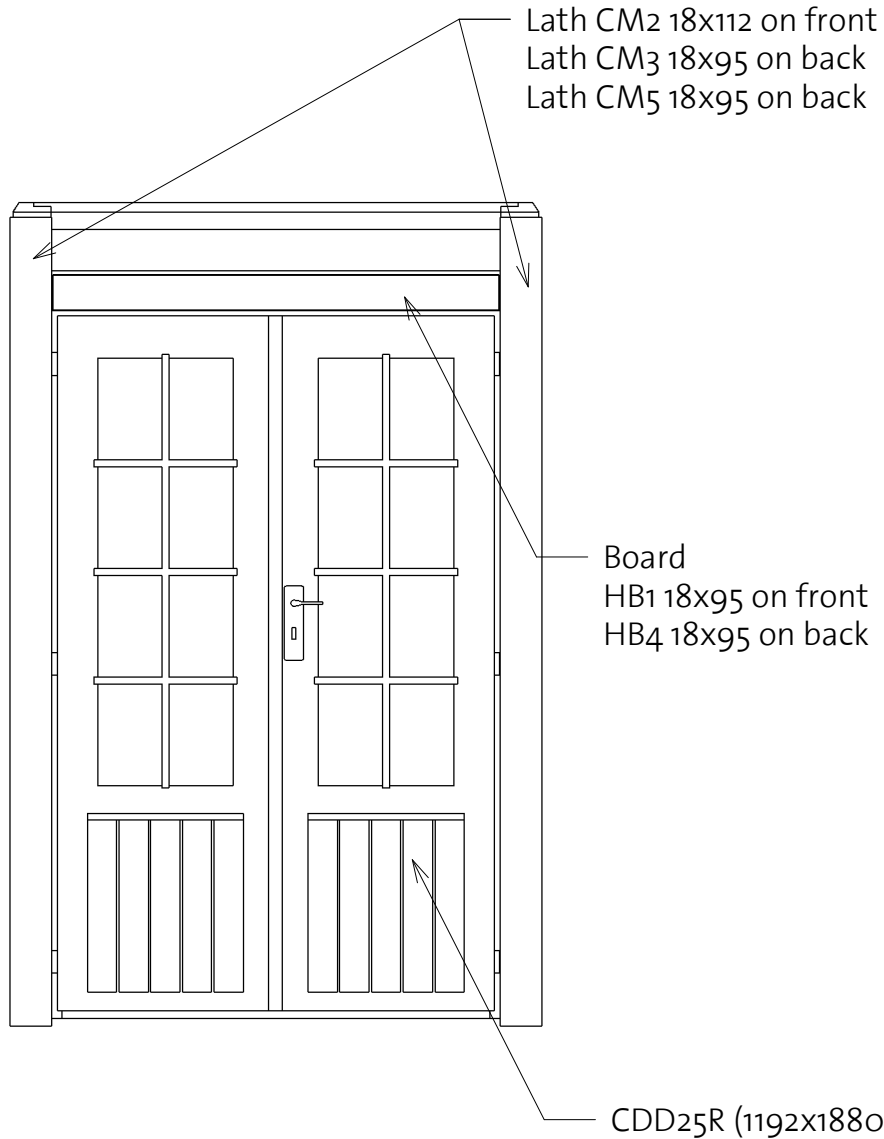
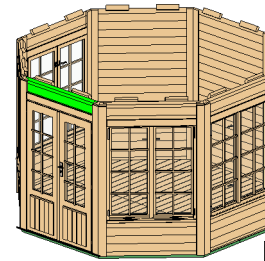

Wall 1		
Mark	Type	Count

WE1	Wall element 1	1
-----	----------------	---

Laths 1				
Mark	Type	Profile	Length	Count

CM2	Lath 18x112		2140	2
CM3	Lath 18x95		2160	1
CM5	Lath 18x95		2160	1

Boards 1				
Mark	Type	Profile	Length	Count

HB1	18x95		1181	1
HB4	18x95		1169	1

# Askersund 40 (336x336)

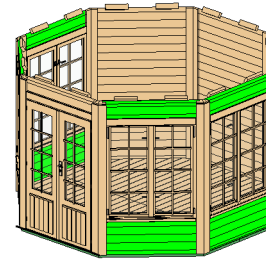

Wall A, B, C, D





Wall A, B, C, D		
Mark	Type	Count

WE2	Wall element 2	4
-----	----------------	---

Laths 2				
Mark	Type	Profile	Length	Count

CM2	Lath 18x112		2140	6
CM3	Lath 18x95		2160	3
CM5	Lath 18x95		2160	3

Boards 2				
Mark	Type	Profile	Length	Count

HB3	18x40		1169	4
HB4	18x95		1169	4

Lath CM2 18x112 on front  
Lath CM3 18x95 on back  
Lath CM5 18x95 on back

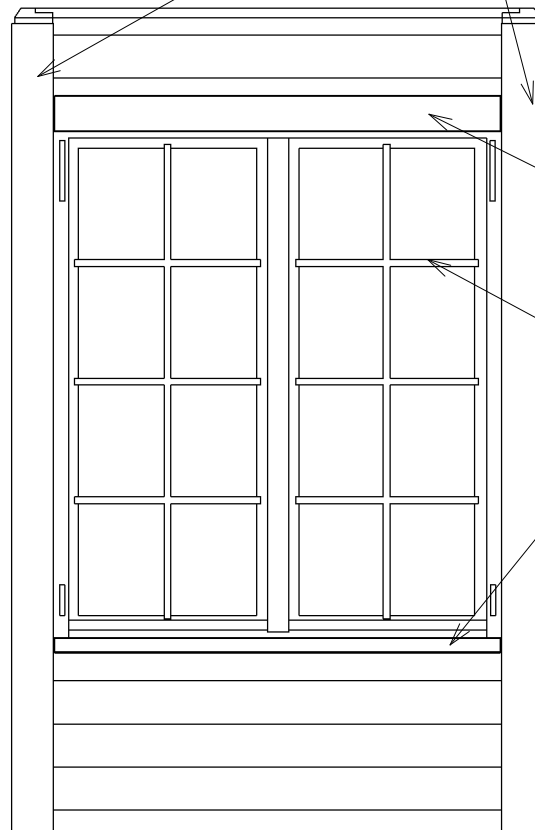



Board HB1 18x95

CDW6 (1192x1368)

Board HB2 18x40

Boards 2				
Mark	Type	Profile	Length	Count

HB1	18x95		1181	4
HB2	18x40		1181	4

# Askersund 40 (336x336)

Wall E, F, 2



Lath CM2 18x112 on front  
Lath CM3 18x95 on back  
Lath CM5 18x95 on back

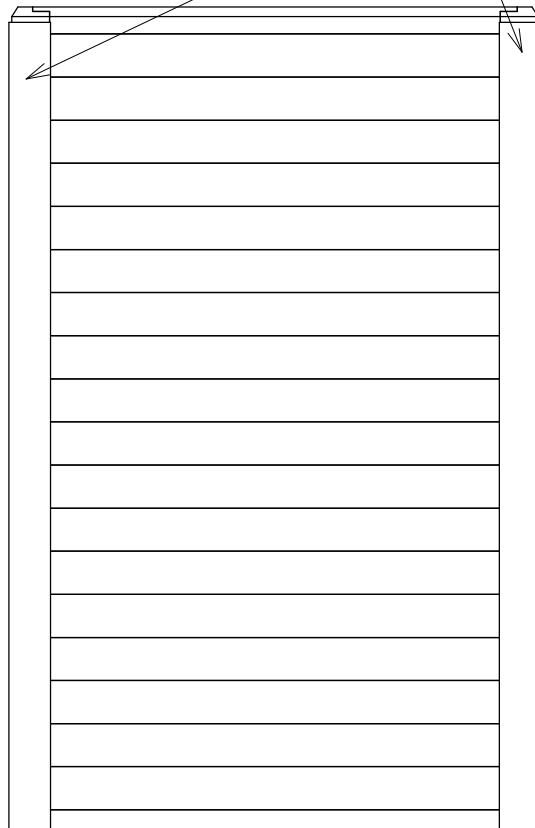

Wall E, F, 2		
Mark	Type	Count

WE3	Wall element 3	3
-----	----------------	---

Laths 3				
Mark	Type	Profile	Length	Count

CM2	Lath 18x112		2140	6
-----	-------------	---	------	---

CM3	Lath 18x95		2160	3
-----	------------	---	------	---

CM5	Lath 18x95		2160	3
-----	------------	--	------	---

# Askersund 40 (336x336)

Roof 1

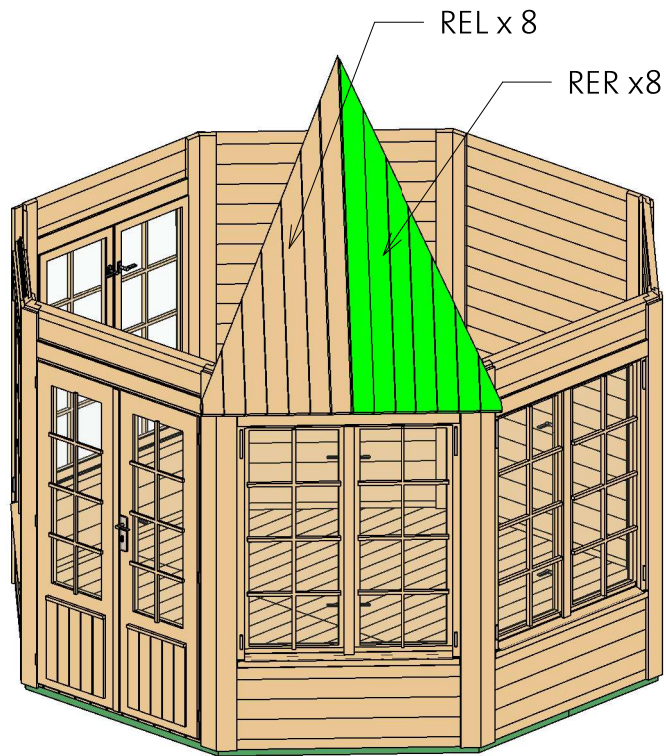

Roof elements		
Name	Type	Count

REL	Roof element left	8
RER	Roof element right	8

② RE

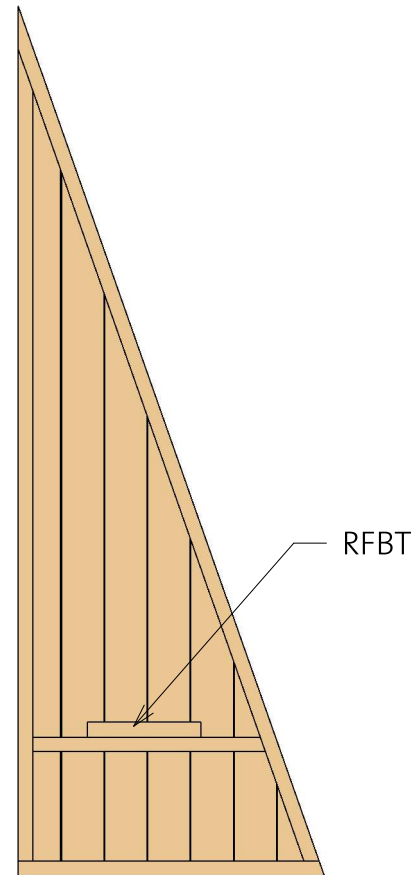

# Askersund 40 (336x336)

Roof 2

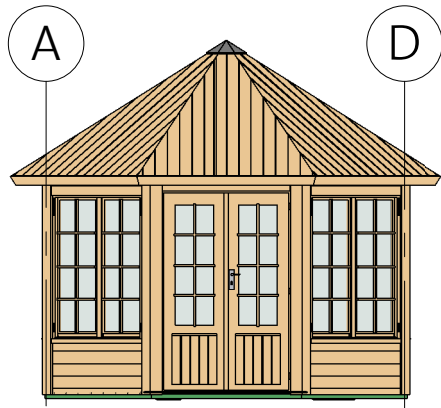

② Roof Reinforcement

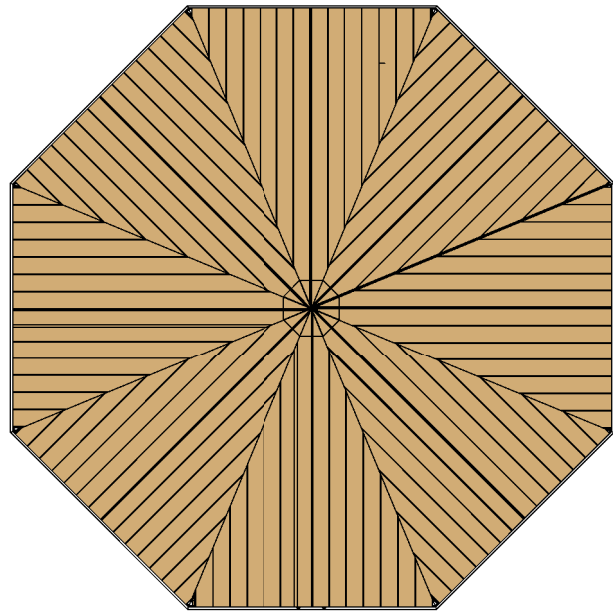
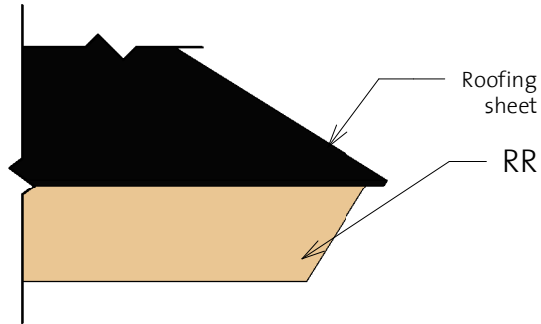

3991

Fascia Schedule				
Mark	Type	Profile	Count	Length
RR	Roof reinforcement 18x95		8	1620

# Askersund 40 (336x336)

## List of all items 1

Floor elements		
Name	Type	Count

FE1	Floor element 1	1
FE2	Floor element 2	1
FE3	Floor element 3	2

Wall elements		
Name	Type	Count

WE1	Wall element 1	1
WE2	Wall element 2	4
WE3	Wall element 3	3

Roof elements		
Name	Type	Count



















① Roof top Octagon



REL	Roof element left	8
RER	Roof element right	8

BB	BB 20x40			1169	7
----	----------	---	---	------	---

RR	Roof reinforcement 18x95			1620	8
----	--------------------------	---	--	------	---





FB11	FB 17x114			1675	2
FB12	FB 17x114			1561	2
FB13	FB 17x114			1447	2
FB14	FB 17x114			1333	2
FB15	FB 17x114			1219	2
FB16	FB 17x114			1105	2
FB17	FB 17x114			991	2
FB18	FB 17x114			877	2
FB19	FB 17x114			763	2

BL-1	40x57			1282	7
------	-------	---	---	------	---

CM2	Lath 18x112	2140	16
CM3	Lath 18x95	2160	8
CM5	Lath 18x95	2160	8
CMI	Post 100x40	100	8

HB1	18x95	1181	5
HB2	18x40	1181	4
HB3	18x40	1169	4
HB4	18x95	1169	5

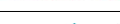
RFBT	40x70	300	16
------	-------	-----	----

Nails	1,4 x 40		30
Screws	5,0 x 70		250
Screws	4,0 x 50		400
Screws	6,0 x 120		65
Screws	4,0 x 40		40
Screws	4,0 x 35		15