

# Boden II 40 (270x360) - PÄRLIN 68

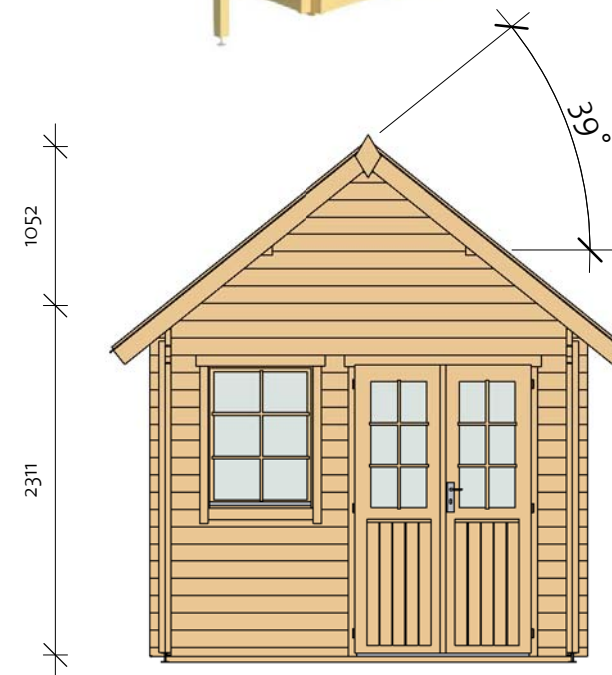

# Boden II 40 (270x360) - PÄRLIN 68

Foundation

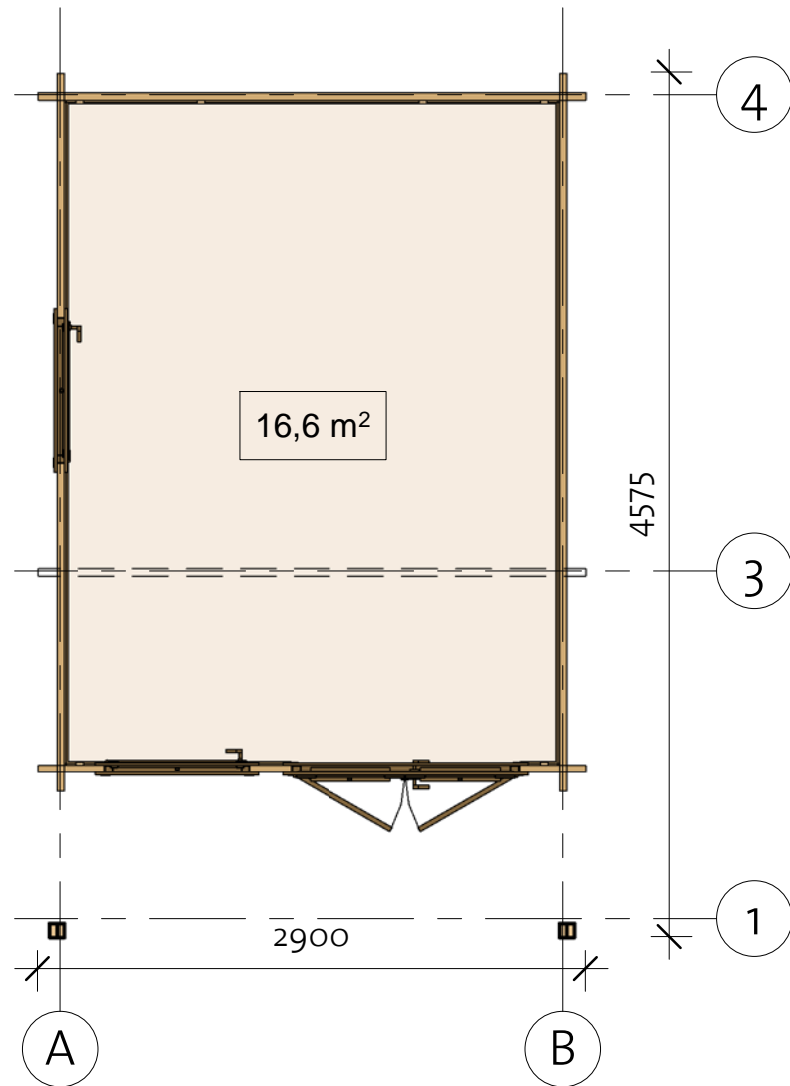
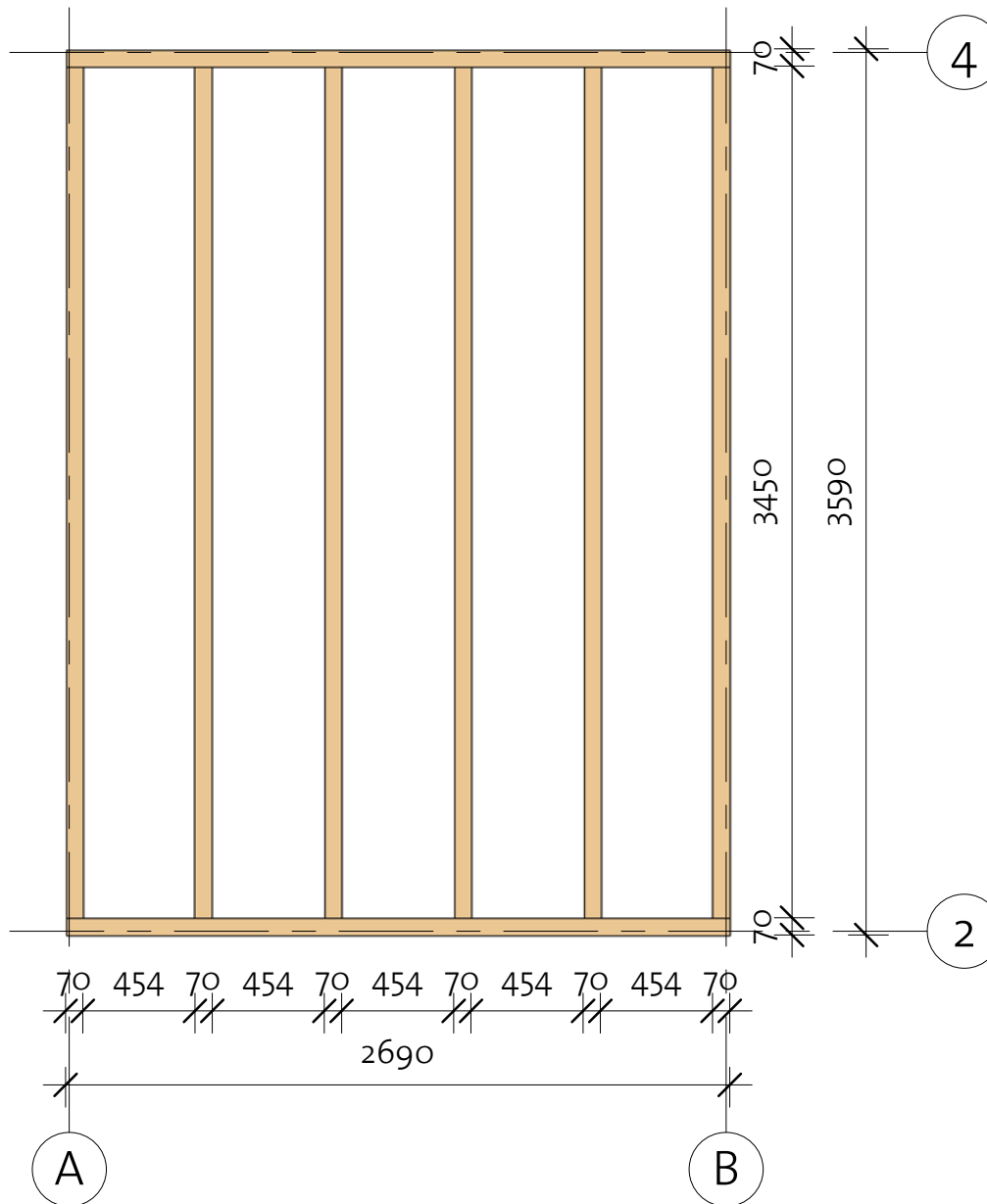





Impregnated foundation beams				
Mark	Type	Profile	Count	Length
IFB1	IFB 70x40		6	3450
IFB2	IFB 70x40		2	2690

# Boden II 40 (270x360) - PÄRLIN 68

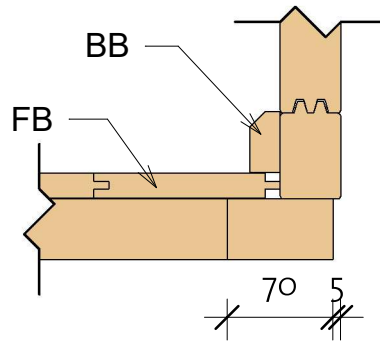
Floor Plan

① Baseboard



Floor Schedule				
Mark	Type	Profile	Count	Length
FB1	FB 17x114		32	2617
FB2	FB 17x114		24	1850
BB	BB 20x40		5	3800

4200002\_200713

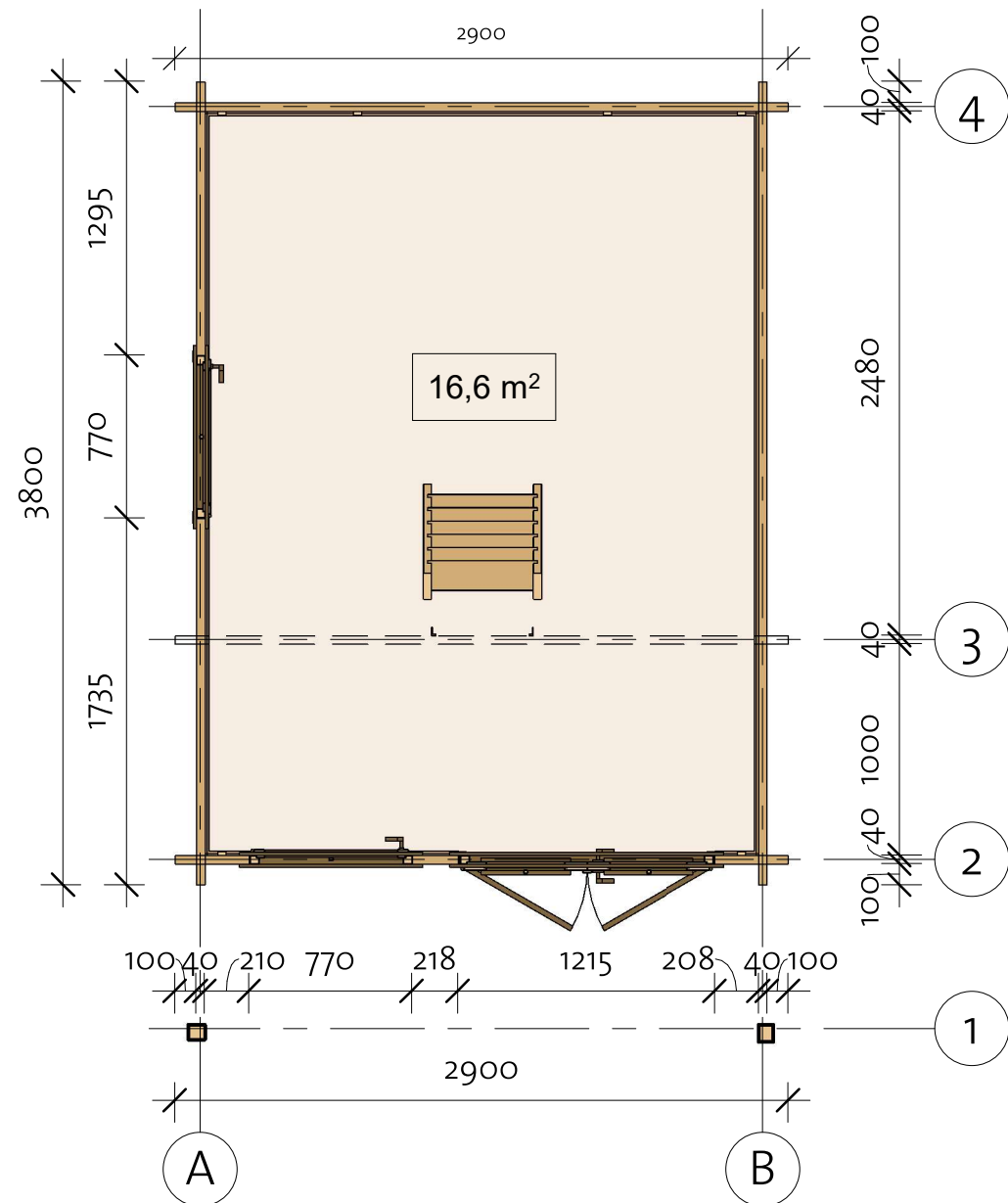

# Boden II 40 (270x360) - PÄRLIN 68

Wall 1

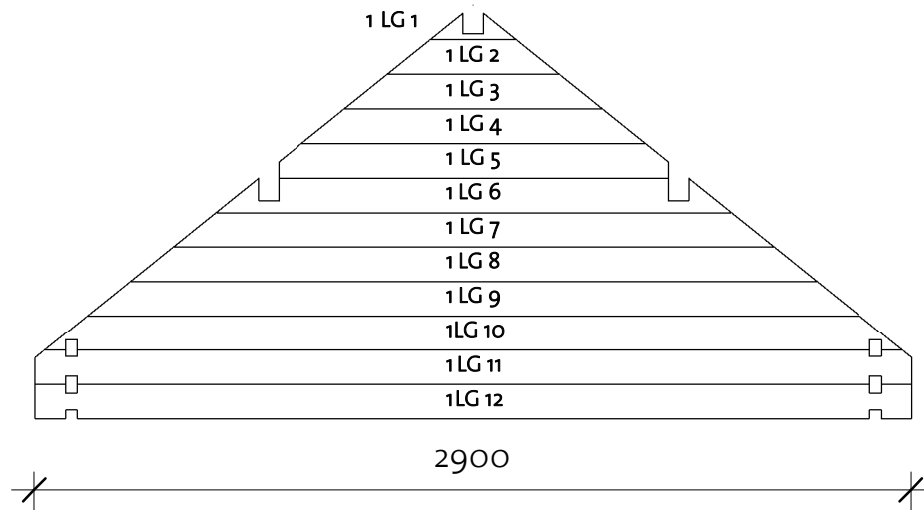
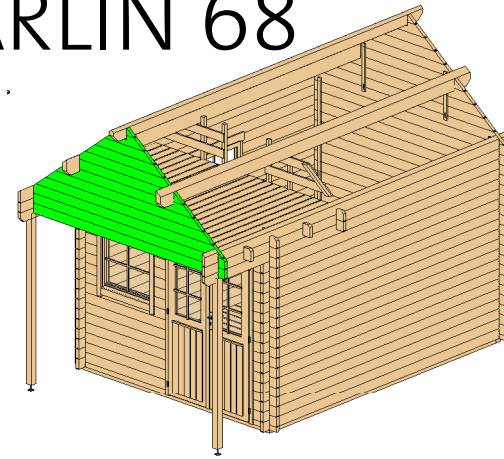

Wall 1			
Mark	Profile	Count	Cut Length

1LG 1 *	40x114	1	284
1LG 2 *	40x114	1	568
1LG 3 *	40x114	1	852
1LG 4 *	40x114	1	1136
1LG 5 *	40x114	1	1286
1LG 6 *	40x114	1	1704
1LG 7 *	40x114	1	1987
1LG 8 *	40x114	1	2271
1LG 9 *	40x114	1	2555
1LG 10 *	40x114	1	2839
1LG 11 *	40x114	1	2900
1LG 12	40x114	1	2900

\* Gable - delivered premounted

Log Profile Wall 1	
Profile	Profile

40x114	
--------	--

# Boden II 40 (270x360) - PÄRLIN 68

Wall 2

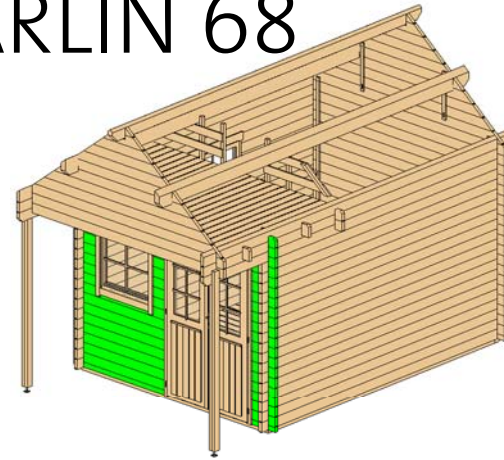

Wall 2			
Mark	Profile	Count	Cut Length

2BL 1	40x57	1	350
2BL 2	40x57	1	1340
2LG 1	40x114	9	220
2LG 2	40x114	26	350
2LG 3	40x114	8	1340
2LG 4	40x114	1	2900
2LG 5	40x114	1	2900

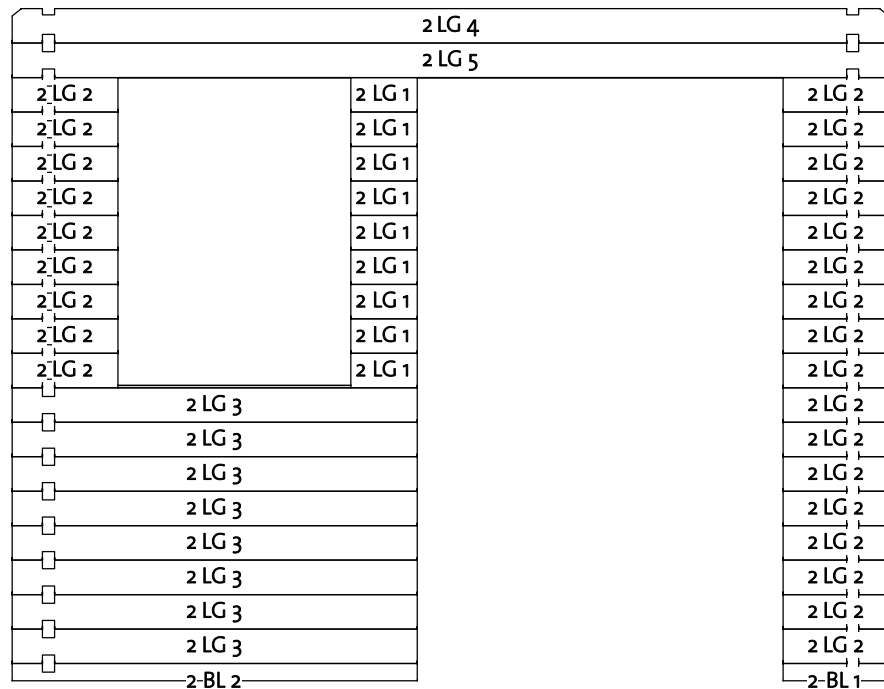

Log Profile Wall 2	
Profile	Images4

40x57	
40x114	
40x114	

# Boden II 40 (270x360) - PÄRLIN 68

Wall 3



Wall 3			
Mark	Profile	Count	Cut Length

3LG 1	40x114	1	2900
3LG 2	40x114	1	2900

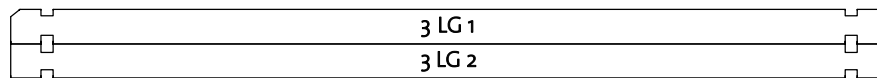

Log Profile Wall 3	
Profile	Images4

40x114	
40x114	

# Boden II 40 (270x360) - PÄRLIN 68

Wall 4

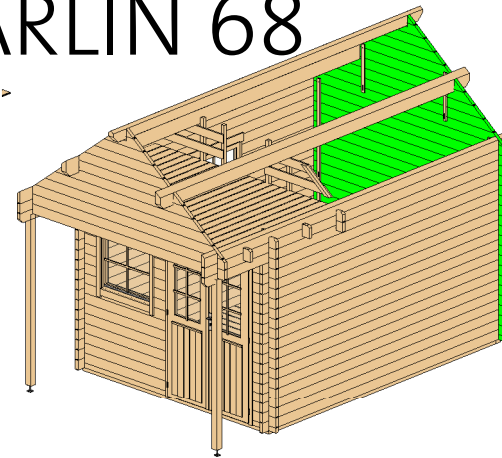
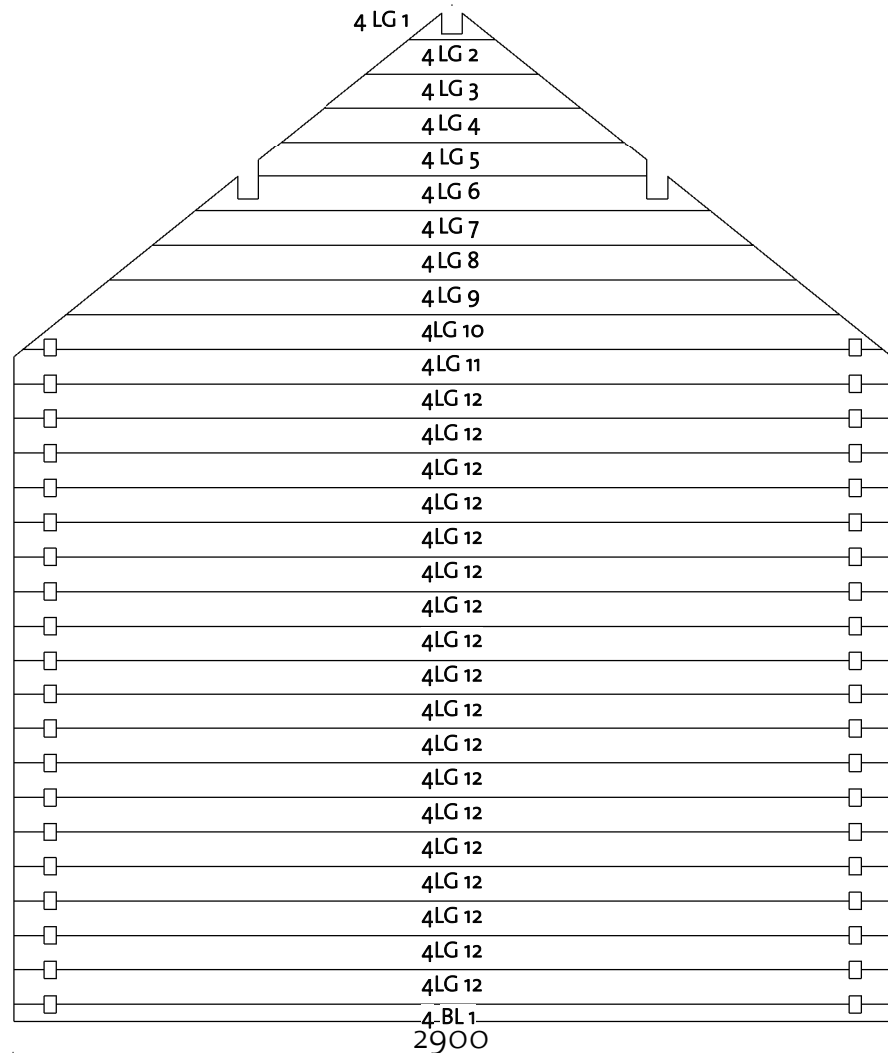

Wall 4			
Mark	Profile	Count	Cut Length

4BL 1	40X57	1	2900
4LG 1 *	40X114	1	284
4LG 2 *	40X114	1	568
4LG 3 *	40X114	1	852
4LG 4 *	40X114	1	1136
4LG 5 *	40X114	1	1286
4LG 6 *	40X114	1	1704
4LG 7 *	40X114	1	1987
4LG 8 *	40X114	1	2271
4LG 9 *	40X114	1	2555
4LG 10 *	40X114	1	2839
4LG 11 *	40X114	1	2900
4LG 12	40X114	18	2900

\* Gable - delivered premounted

Log Profile Wall 4	
Profile	Profile

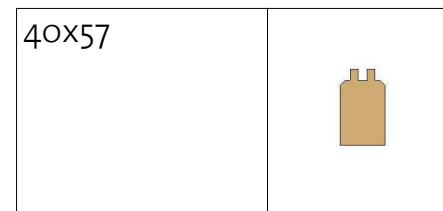

Log Profile Wall 4	
Profile	Profile

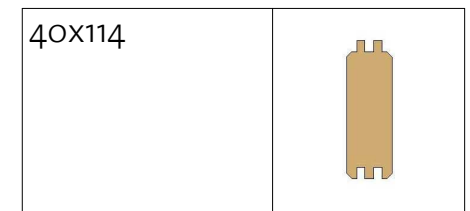

# Boden II 40 (270x360) - PÄRLIN 68

Wall A

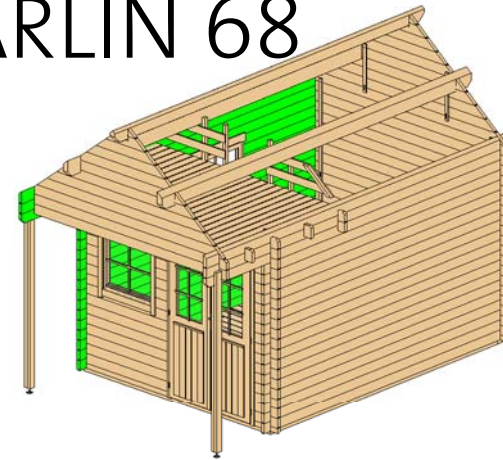

Wall A			
Mark	Profile	Count	Cut Length

ALG 1	40x114	9	1295
ALG 2	40x114	9	1735
ALG 3	40x114	8	3800
ALG 4	40x114	1	4700
ALG 5	40x114	1	4800
ATL 1	40x145	1	4800

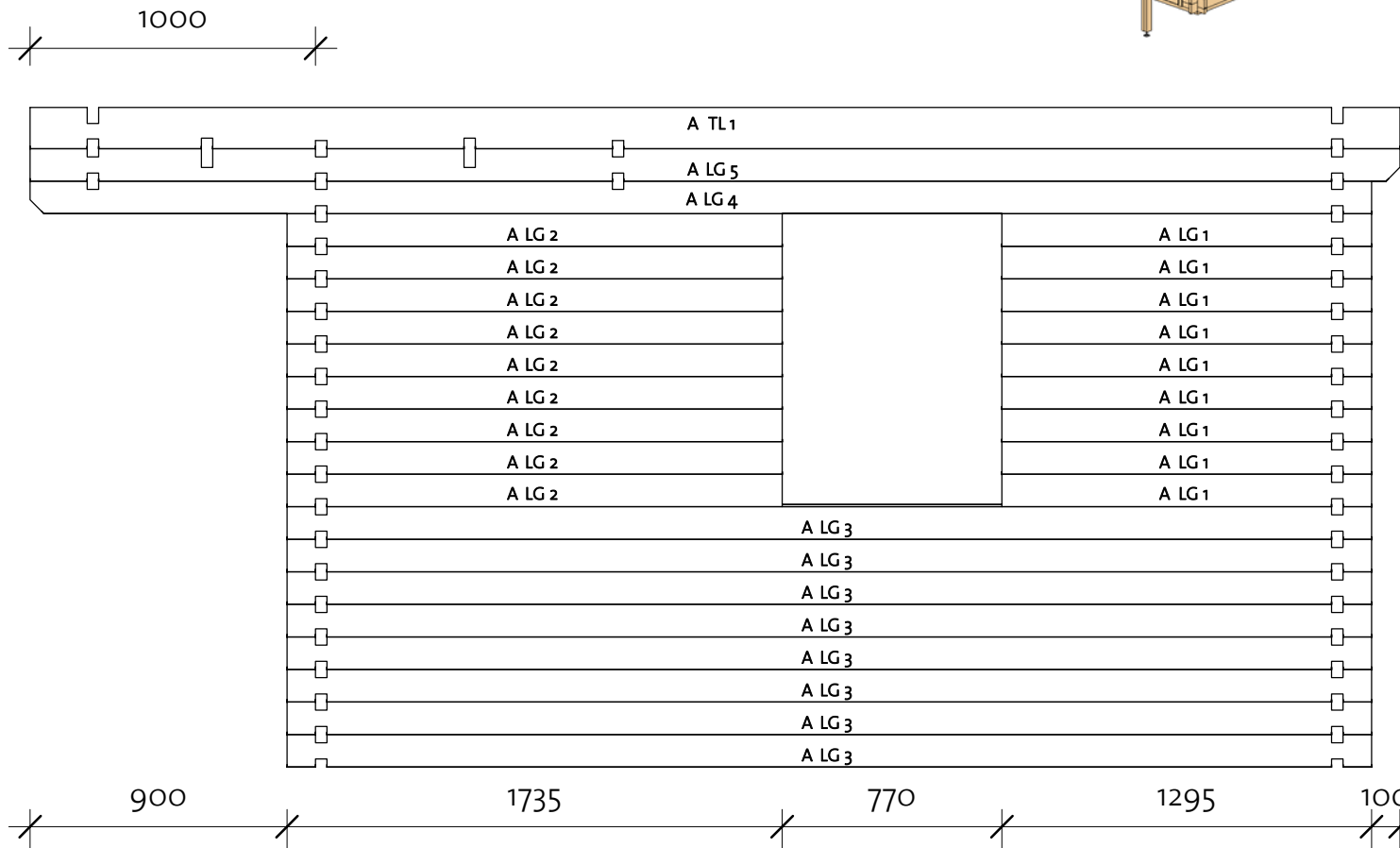

Log Profile Wall A	
Profile	Profile

40x114	
40x145	



# Boden II 40 (270x360) - PÄRLIN 68

Wall B

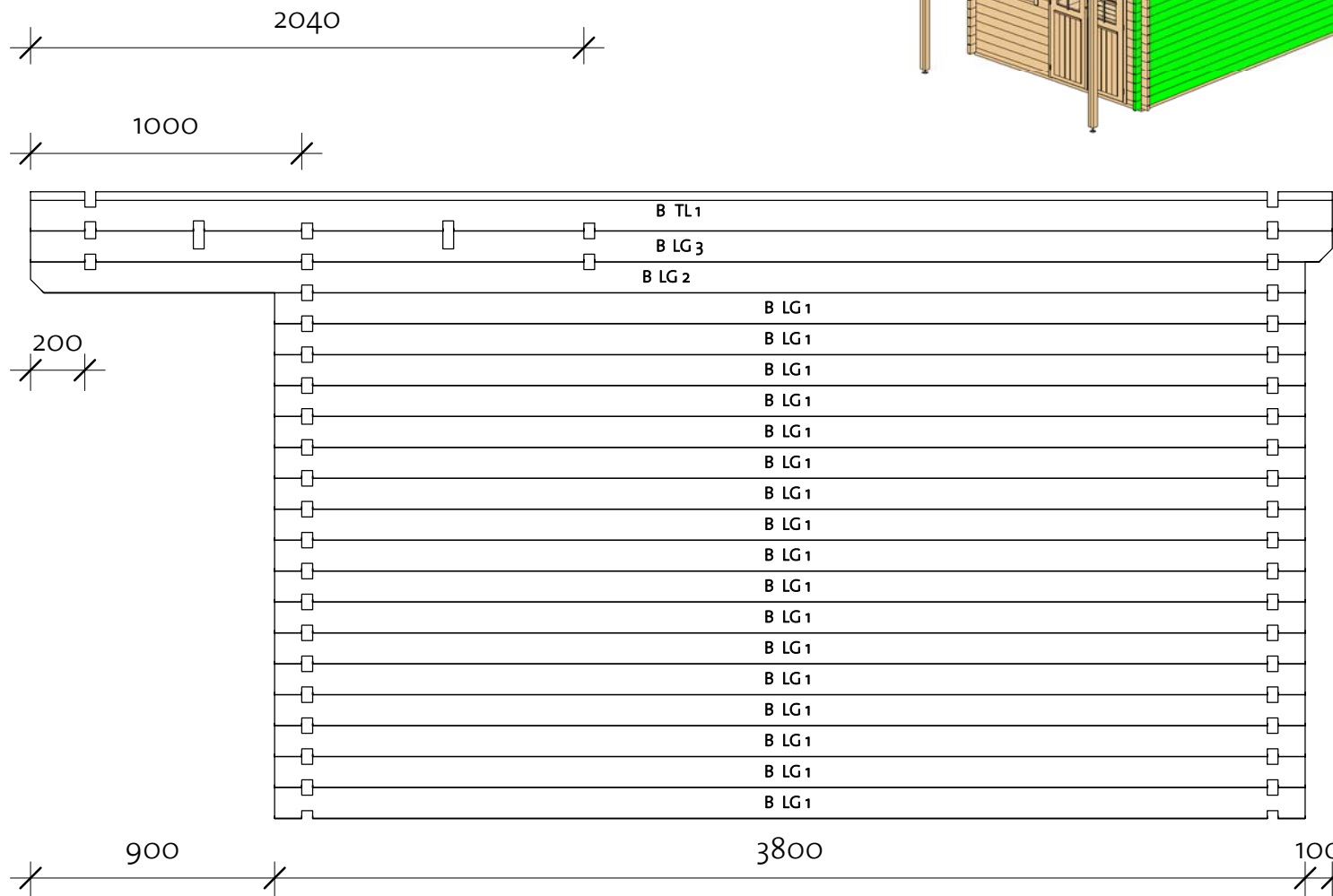

4200002\_190910

Wall B			
Mark	Profile	Count	Cut Length

BLG 1	40x114	17	3800
BLG 2	40x114	1	4700
BLG 3	40x114	1	4800
BTL 1	40x145	1	4800

Log Profile Wall B	
Profile	Profile

40x114	
40x145	

# Boden II 40 (270x360) - PÄRLIN 68

Second floor

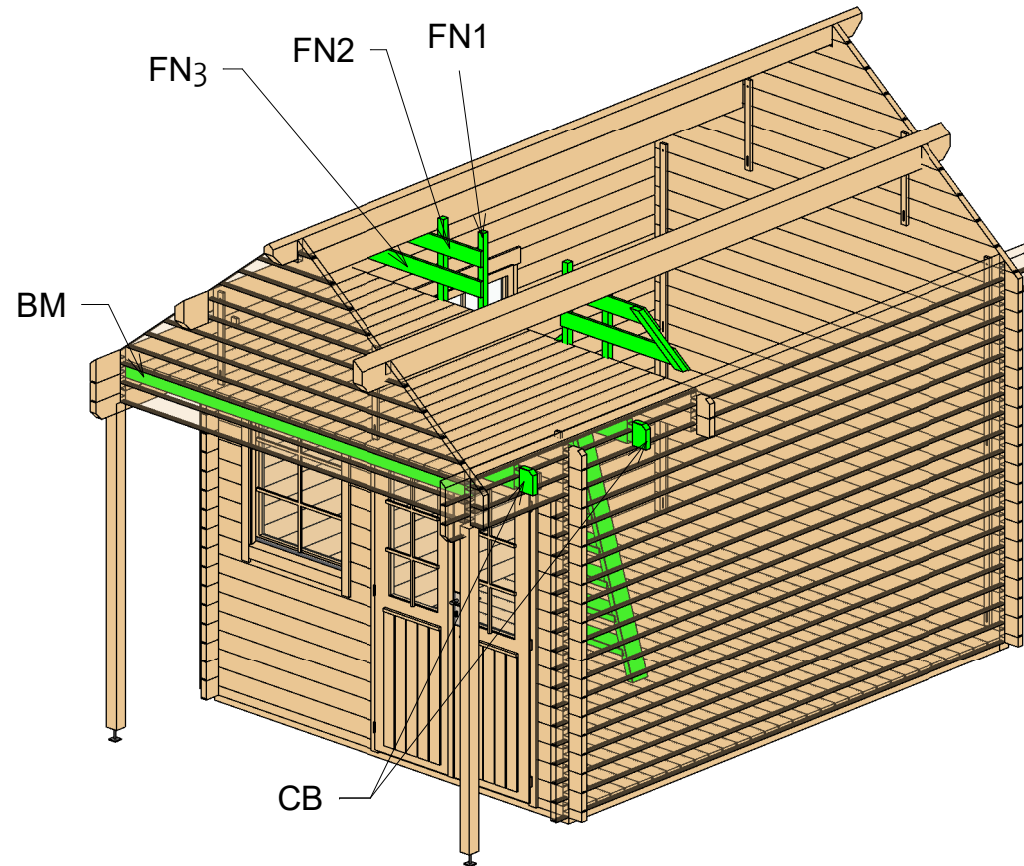

Second floor				
Mark	Type	Profile	Count	Cut Length
FN3	Fence3 18x95		2	968
BM	Beam 40x90		1	2620
CB	Ceiling beam 40x143		2	2900
FN1	Fence1 38x38		6	680
FN2	Fence2 18x95		2	743

# Boden II 40 (270x360) - PÄRLIN 68

Roof 1

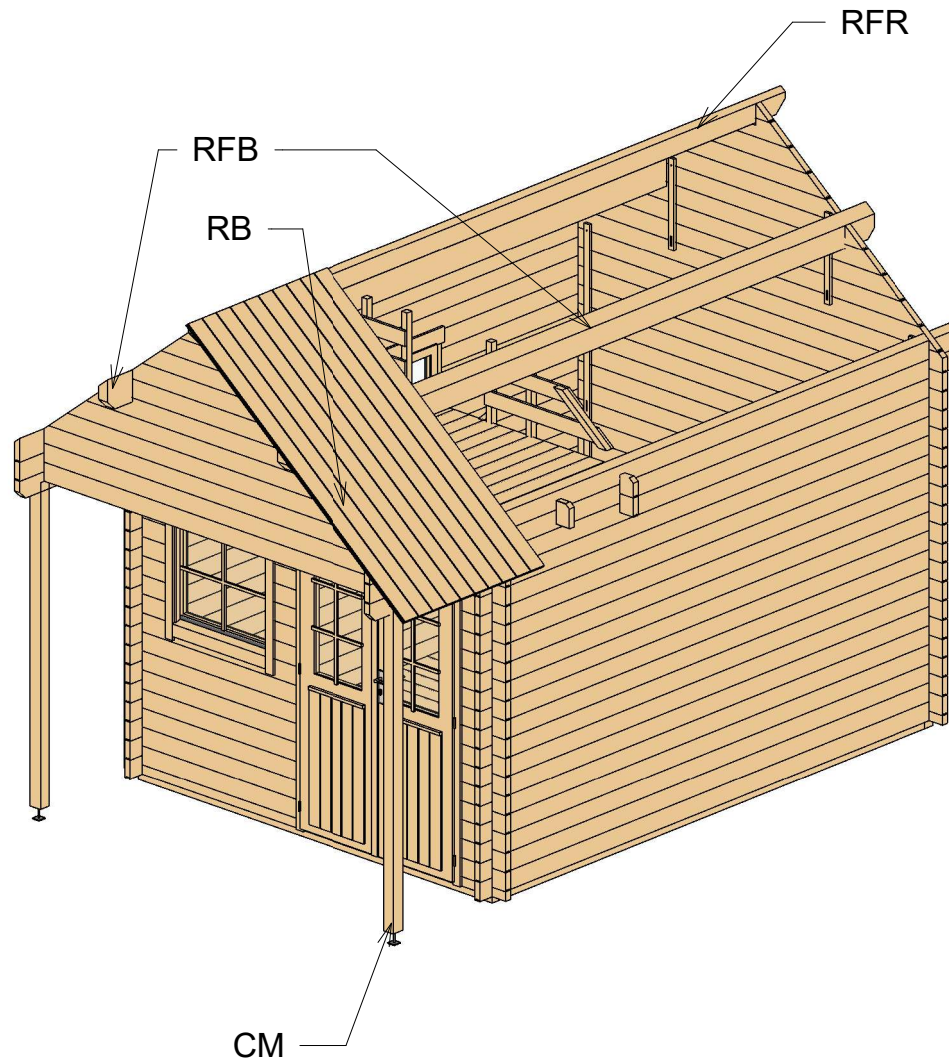

Roof				
Mark	Type	Profile	Count	Length
RFR	Ridge 68x143		1	4800
RFB	Beam 68x193		2	4800
RB	17x114		86	2120

Post			
Mark	Profile	Count	Length
CM	Post 80x70	2	1960

# Boden II 40 (270x360) - PÄRLIN 68

Fascia Schedule				
Mark	Type	Profile	Count	Length

Roof 2

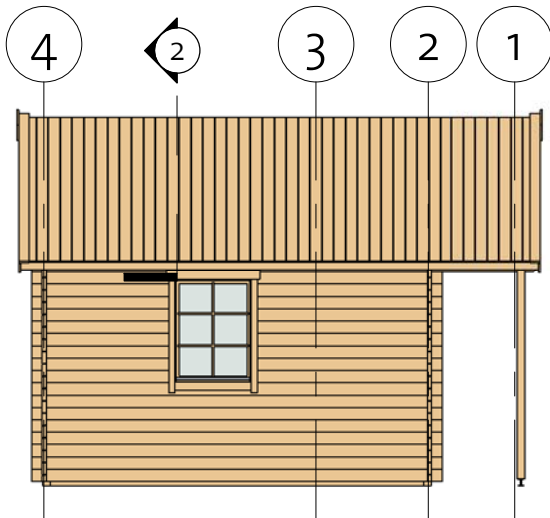

② Facia

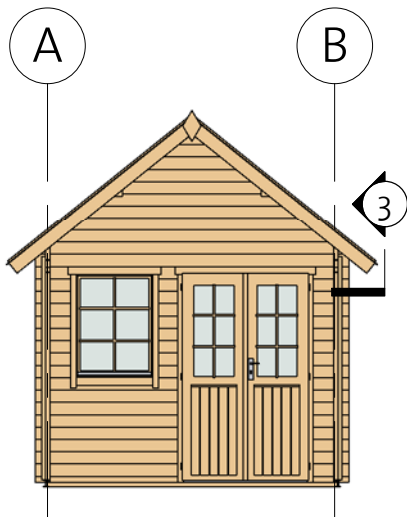
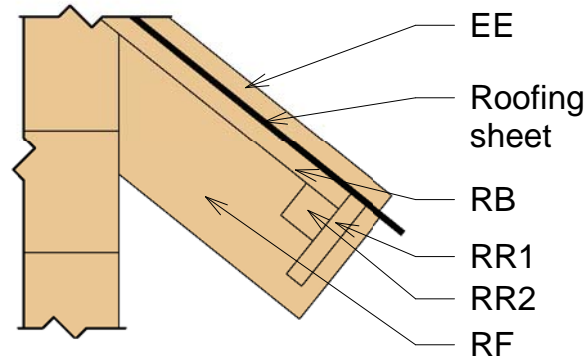

③ Roof Reinforcement

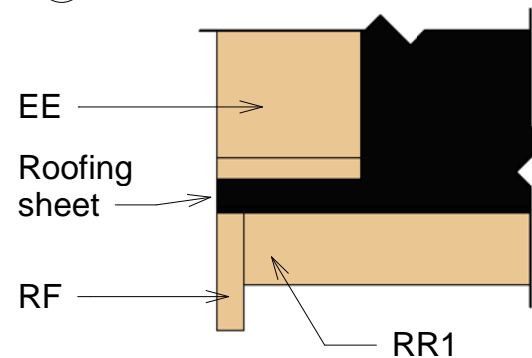

EE	Eave Edging 18x95		4	2170
RF	Roof Fascia 18x120		4	2170
RR1	Roof reinforcement 18x95		2	4800
RR2	Roof reinforcement 38x38		2	4800

# Boden II 40 (270x360) - PÄRLIN 68

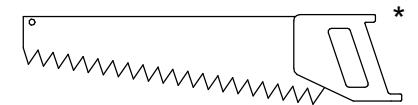
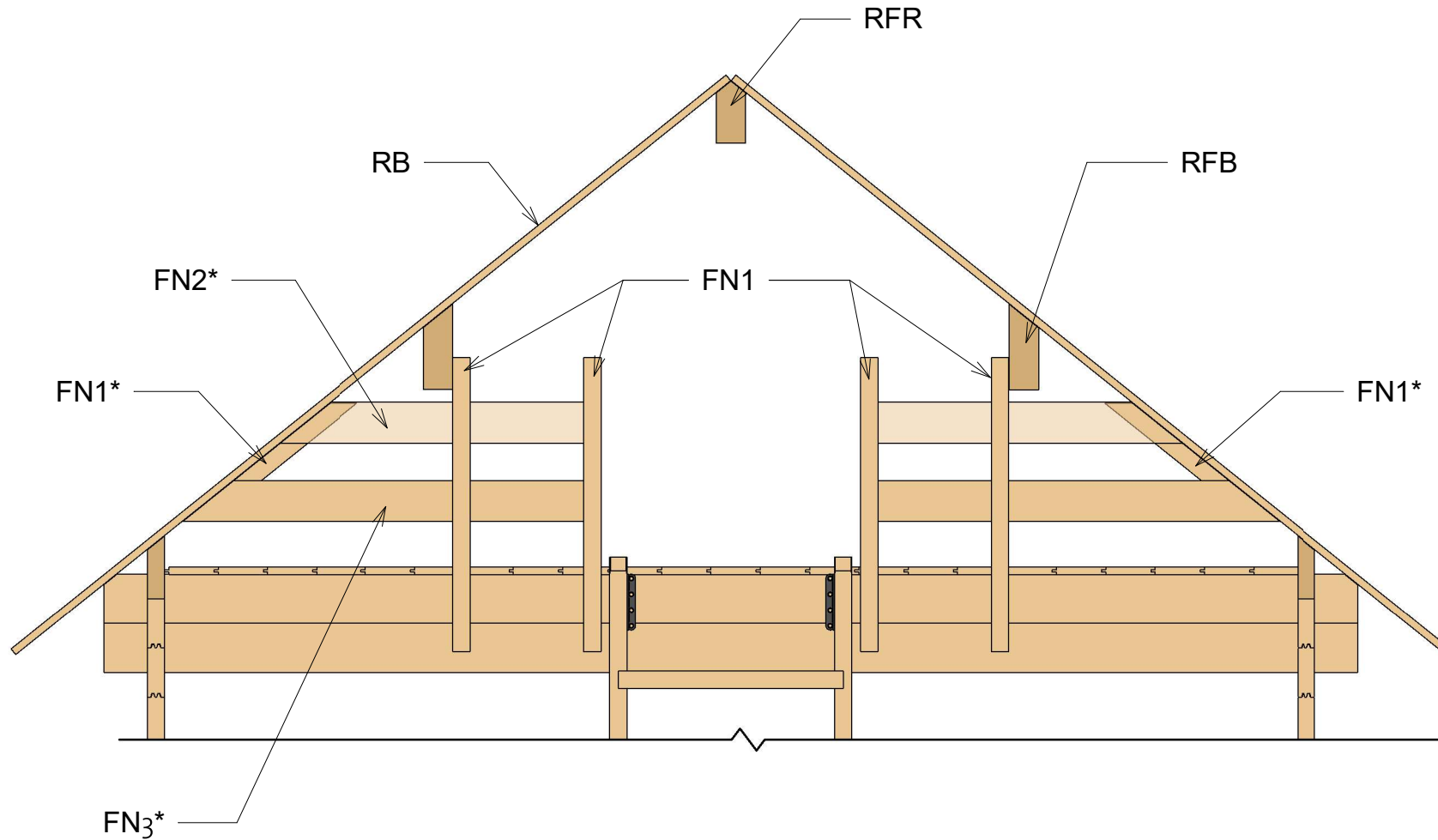

Fence

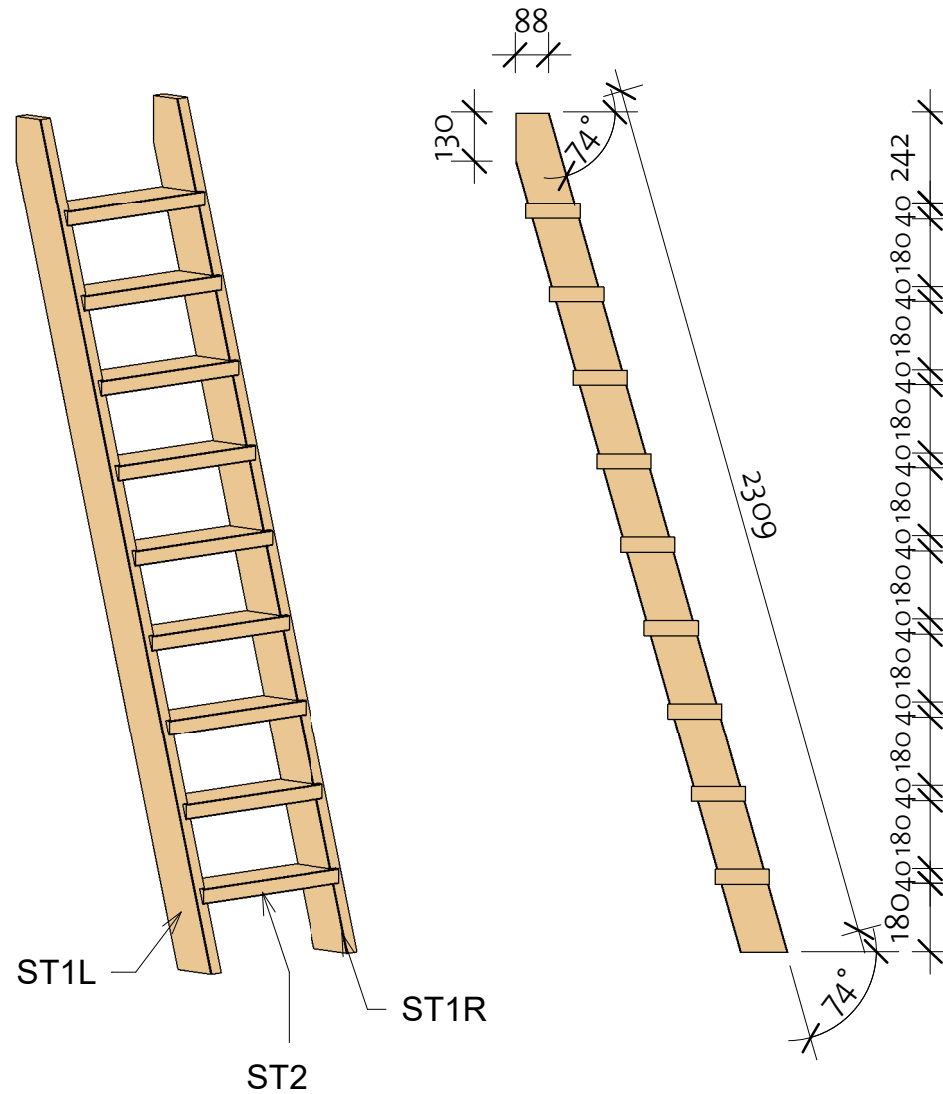

# Boden II 40 (270x360) - PÄRLIN 68

Stair



Stairs				
Mark	Profile	Profile	Count	Cut Length
ST1L	40X120		1	2333
ST1R	40X120		1	2333
ST2	143X40		9	520

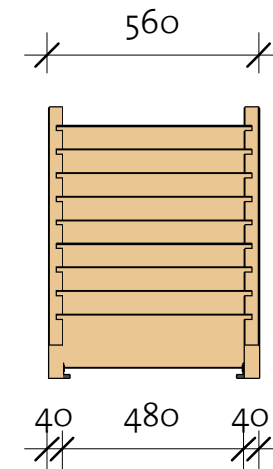

# Boden II 40 (270x360) - PÄRLIN 68

Extras

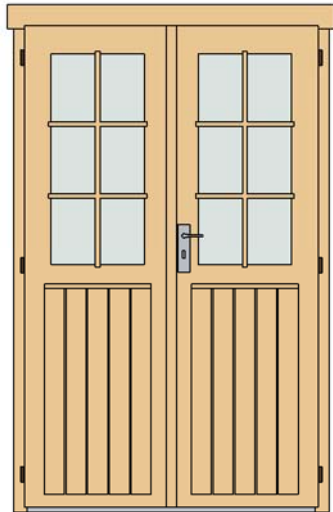

Door Schedule				
Model	Type	Width	Height	Count
CDD5R	Classic double door 5 right	1200	1955	1
DCB6-5	Door Crossbar 6-5	--	--	2

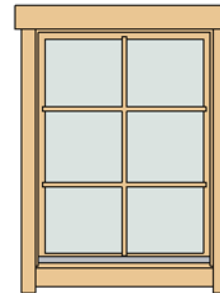

Window Schedule				
Model	Type	Width	Height	Count
CW1R	Classic window 1 right	765	990	2
WCB6	Windows Crossbar 6	--	--	2

Fasteners & Extras		
Name	Type	Count

Hitblock	300-400 mm	
Ladder fittings		2
Screws	6,0x160	6
Bolts	M8 x 70	20
Screws	5,0 x 70	45
Nails	1,4 x 40	50
Screws	6,0 x 140	80
Screws	4,0 x 40	120
Screws	4,0 x 50	700



Type	Count	Length
Adjustable post foot	2	63
Windboard1 18x40	4	2200
Windboard2 18x40	4	550

Family	Count
Romb	2





4200002\_190910

# Boden II 40 (270x360) - PÄRLIN 68

## List of all items 1

### Impregnated foundation beams



Mark	Type	Profile	Count	Length
------	------	---------	-------	--------

IFB1	IFB 70x40		6	3450
IFB2	IFB 70x40		2	2690

BB	BB 20x40		5	3800
----	-------------	-----------------------------------------------------------------------------------	---	------



### Floor Schedule

Mark	Type	Profile	Count	Length
------	------	---------	-------	--------

FB1	FB 17x114		32	2617
FB2	FB 17x114		24	1850



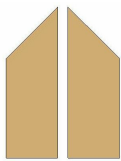

### Roof

Mark	Type	Profile	Count	Length
------	------	---------	-------	--------

RFR	Ridge 68x143		1	4800
RFB	Beam 68x193		2	4800
RB	17x114		86	2120

### Fascia Schedule

Mark	Type	Profile	Count	Length
------	------	---------	-------	--------

EE	Eave Edging 18x95		4	2170
RF	Roof Fascia 18x120		4	2170
RR1	Roof reinforcement 18x95		2	4800
RR2	Roof reinforcement 38x38		2	4800



# Boden II 40 (270x360) - PÄRLIN 68

## List of all items 2

Wall 1			
Mark	Profile	Count	Cut Length

1LG 1 *	40X114	1	284
1LG 2 *	40X114	1	568
1LG 3 *	40X114	1	852
1LG 4 *	40X114	1	1136
1LG 5 *	40X114	1	1286
1LG 6 *	40X114	1	1704
1LG 7 *	40X114	1	1987
1LG 8 *	40X114	1	2271
1LG 9 *	40X114	1	2555
1LG 10 *	40X114	1	2839
1LG 11 *	40X114	1	2900
1LG 12	40X114	1	2900

Wall 4			
Mark	Profile	Count	Cut Length

4BL 1	40X57	1	2900
4LG 1 *	40X114	1	284
4LG 2 *	40X114	1	568
4LG 3 *	40X114	1	852
4LG 4 *	40X114	1	1136
4LG 5 *	40X114	1	1286
4LG 6 *	40X114	1	1704
4LG 7 *	40X114	1	1987
4LG 8 *	40X114	1	2271
4LG 9 *	40X114	1	2555
4LG 10 *	40X114	1	2839
4LG 11 *	40X114	1	2900
4LG 12	40X114	18	2900

Wall 2			
Mark	Profile	Count	Cut Length



2BL 1	40X57	1	350
2BL 2	40X57	1	1340
2LG 1	40X114	9	220
2LG 2	40X114	26	350
2LG 3	40X114	8	1340
2LG 4	40X114	1	2900
2LG 5	40X114	1	2900

Wall 3			
Mark	Profile	Count	Cut Length

3LG 1	40X114	1	2900
3LG 2	40X114	1	2900

\*Gable-delivered premounted

Log Profiles 1	
Profile	Profile

40X57	
40X114	
40X114	

# Boden II 40 (270x360) - PÄRLIN 68

## List of all items 3

Wall A			
Mark	Profile	Count	Cut Length

ALG 1	40x114	9	1295
ALG 2	40x114	9	1735
ALG 3	40x114	8	3800
ALG 4	40x114	1	4700
ALG 5	40x114	1	4800
ATL 1	40x145	1	4800

Wall B			
Mark	Profile	Count	Cut Length





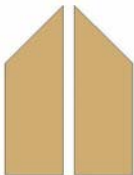



BLG 1	40x114	17	3800
BLG 2	40x114	1	4700
BLG 3	40x114	1	4800
BTL 1	40x145	1	4800

Log Profiles 2	
Profile	Profile

40x114	
40x145	

# Boden II 40 (270x360) - PÄRLIN 68

## List of all items 4

Second floor					Stairs				
Mark	Type	Profile	Count	Cut Length	Mark	Profile	Profile	Count	Cut Length
FN3	Fence3 18x95		2	968	ST1L	40x120		1	2333
BM	Beam 40x90		1	2620	ST1R	40x120		1	2333
CB	Ceiling beam 40x143		2	2900	ST2	143x40		9	520
FN1	Fence1 38x38		6	680					
FN2	Fence2 18x95		2	743					

Post			
Mark	Profile	Count	Length
CM	Post 80x70	2	1960