

Diana 40 (360x550)

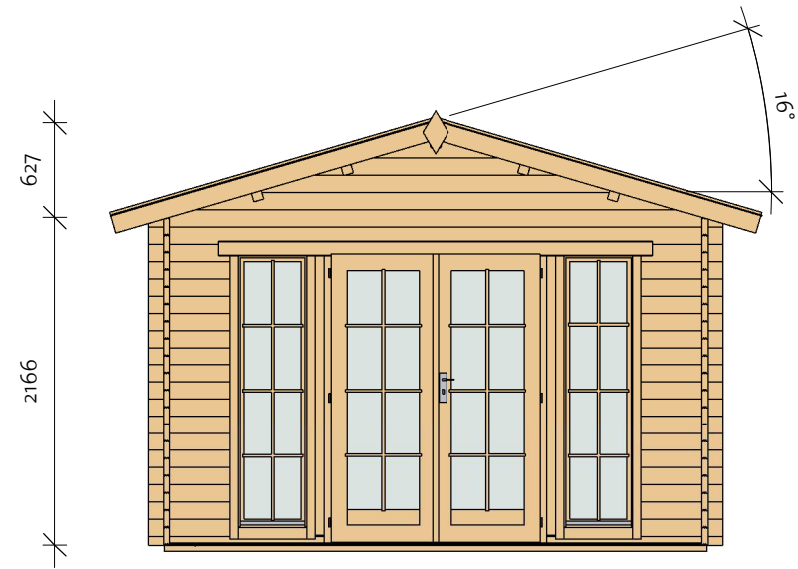

Diana 40 (360x550)

Foundation

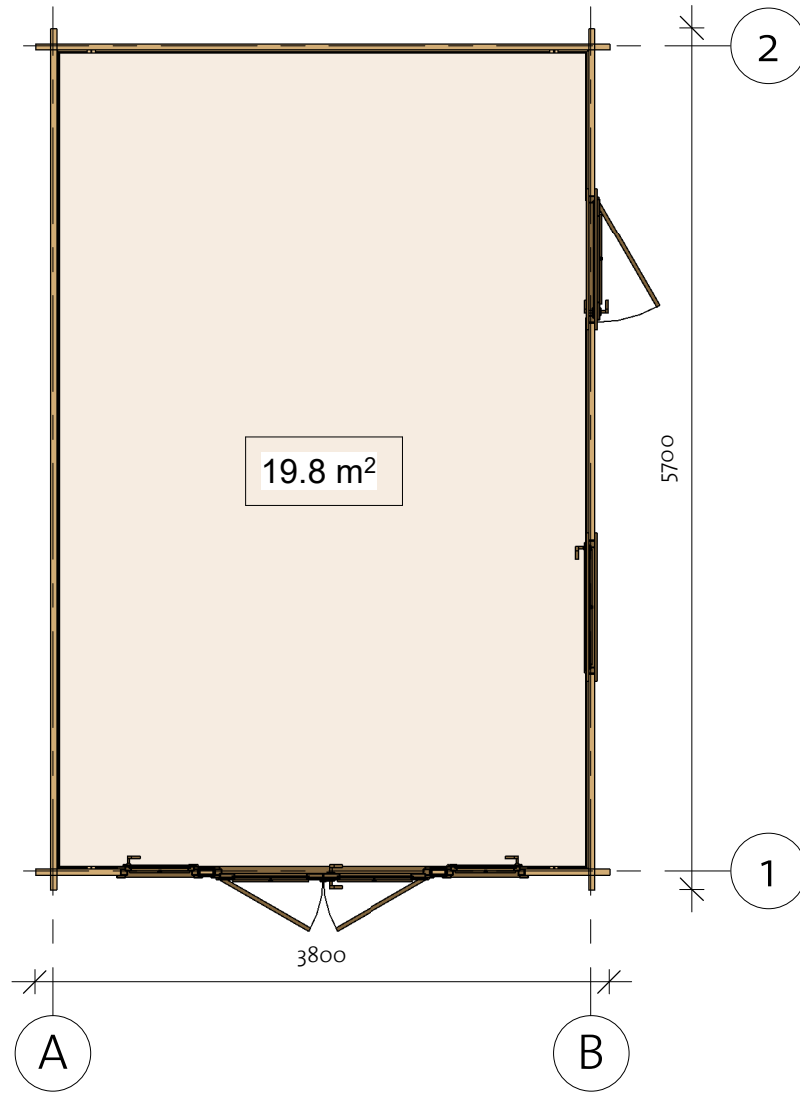
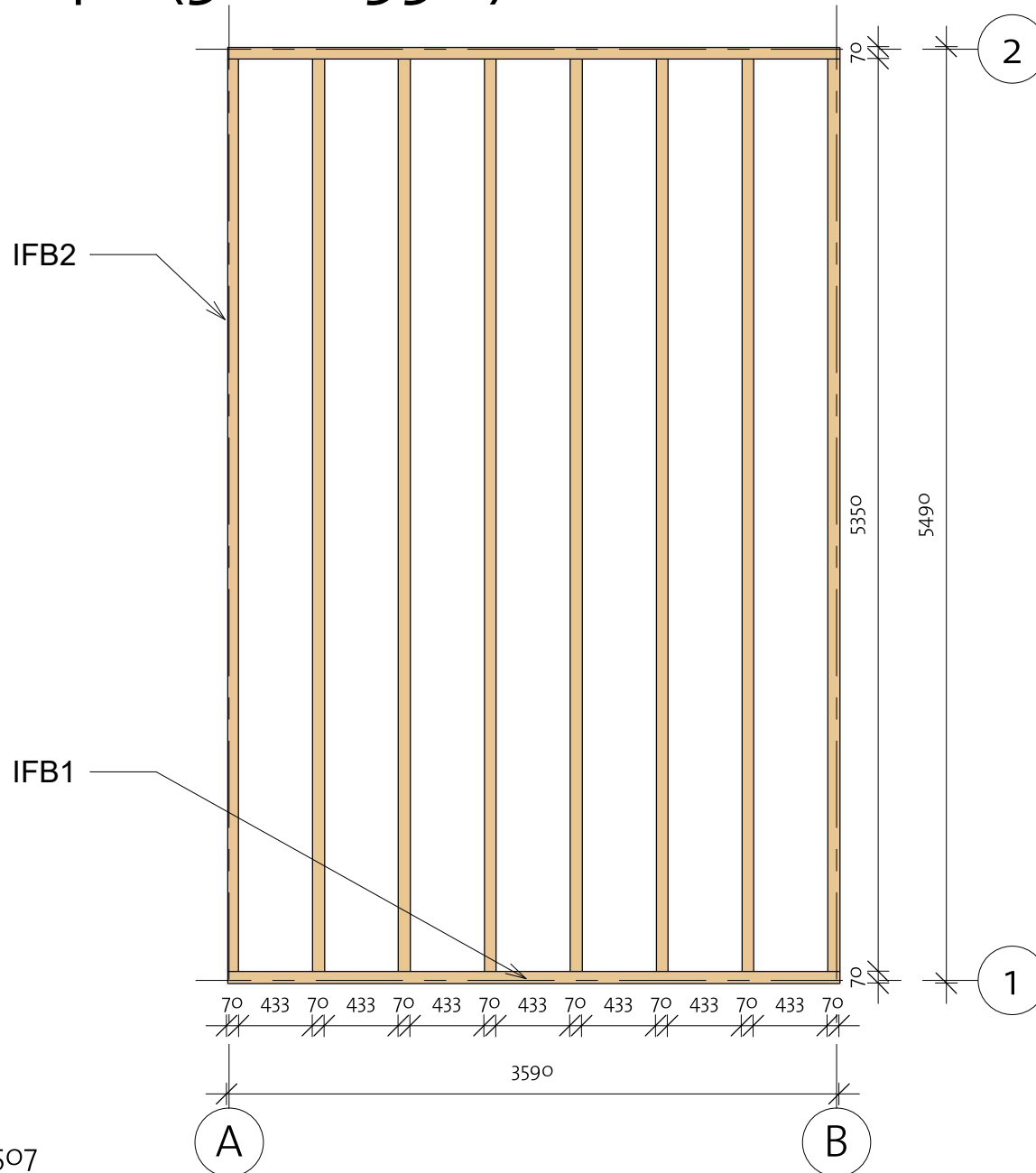

| Impregnated foundation beams | | | | |
|------------------------------|--------------|---------|-------|--------|
| Mark | Type | Profile | Count | Length |
| IFB1 | IFB 70x40 | | 8 | 5350 |
| IFB2 | IFB 70x40 | | 2 | 3590 |



Diana 40 (360x550)

Floor Plan

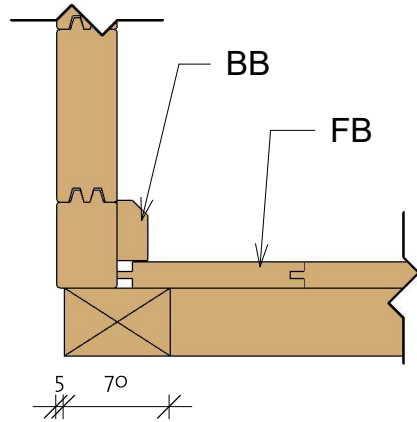
① Baseboard



Floor Schedule

| Mark | Type | Profile | Count | Length |
|------|-----------|---|-------|--------|
| FB | FB 17x114 |  | 49 | 3517 |
| BB1 | BB 20x40 |  | 2 | 3600 |
| BB2 | BB 20x40 | | 2 | 5500 |

91811052_200507

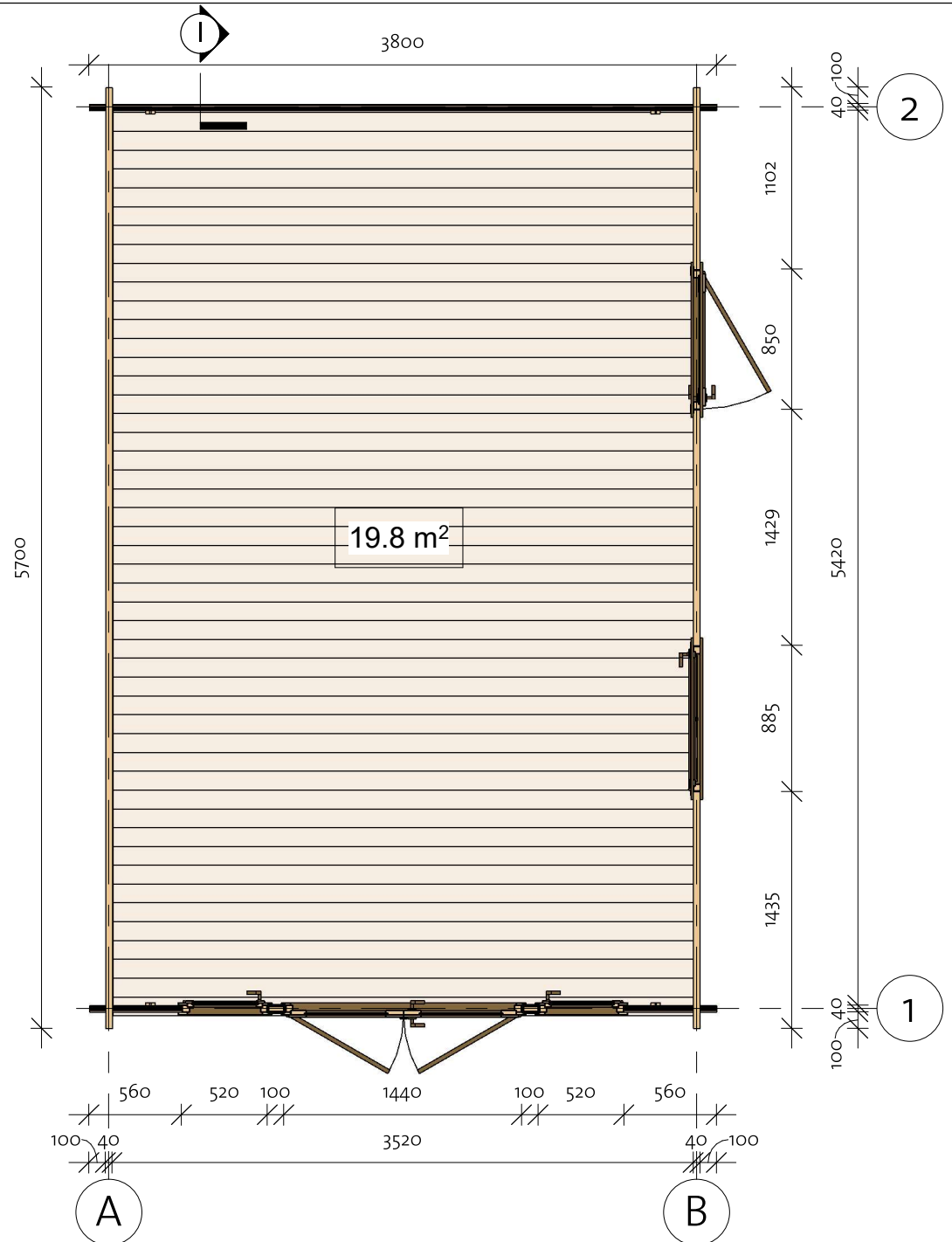

Diana 40 (360x550)

Wall 1

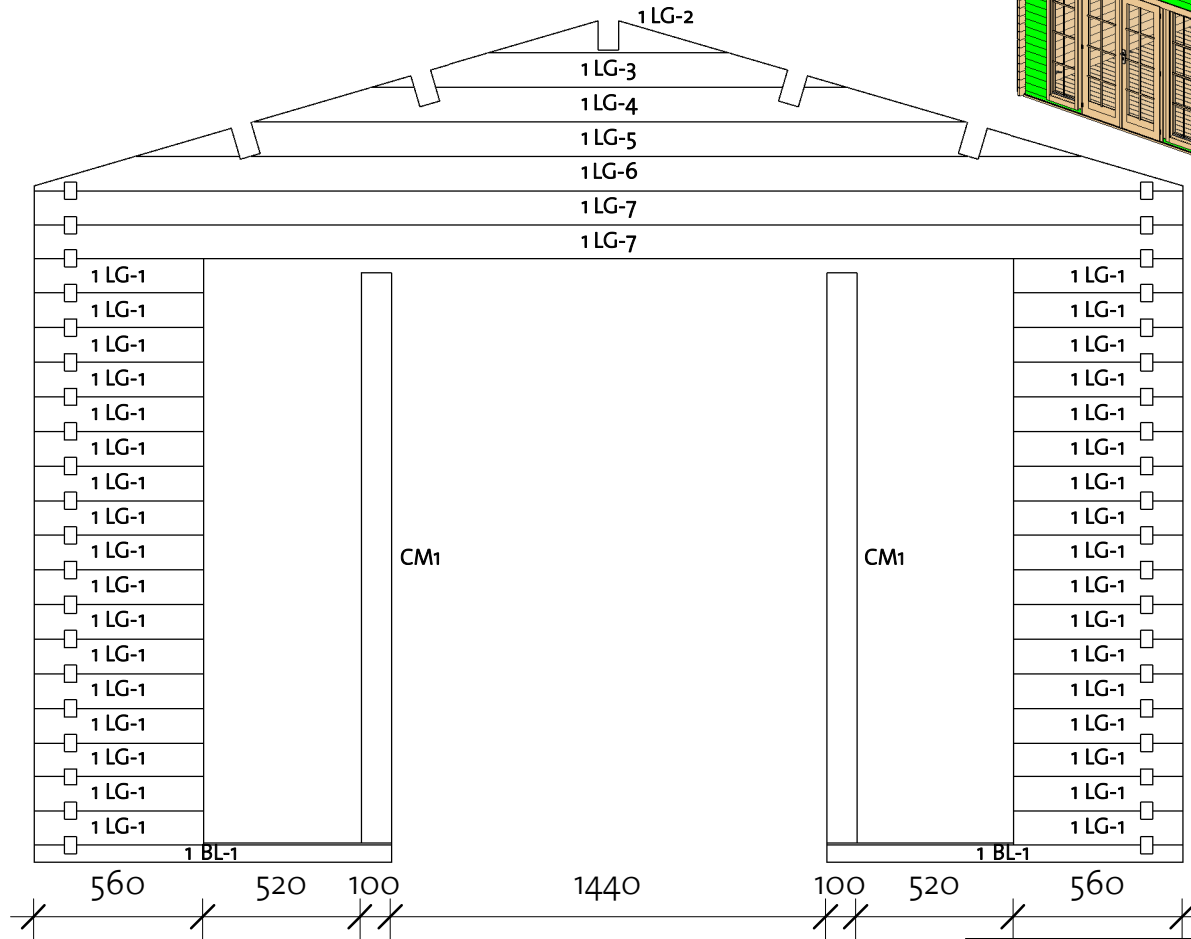
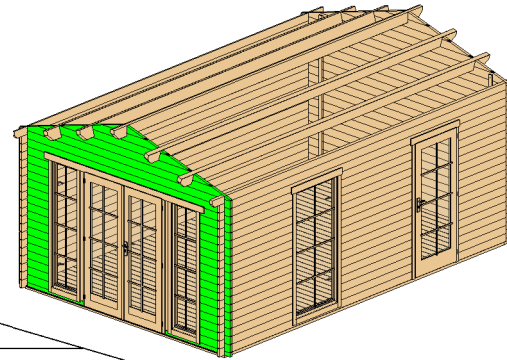



| Wall 1 | | | |
|--------|---------|-------|------------|
| Mark | Profile | Count | Cut Length |

| | | | |
|--------|--------|----|------|
| 1BL-1 | 40X57 | 2 | 1180 |
| 1LG-1 | 40X114 | 34 | 560 |
| 1LG-2* | 40X114 | 1 | 791 |
| 1LG-3* | 40X114 | 1 | 1571 |
| 1LG-4* | 40X114 | 1 | 2351 |
| 1LG-5* | 40X114 | 1 | 3130 |
| 1LG-6* | 40X114 | 1 | 3800 |
| 1LG-7 | 40X114 | 2 | 3800 |

* Gable - delivered premounted

| Log Profile Wall 1 | |
|--------------------|---------|
| Profile | Profile |

| | |
|--------|---|
| 40X57 |  |
| 40X114 |  |

| Columns | | | |
|---------|-------------|-------|--------|
| Mark | Profile | Count | Length |
| CM1 | Post 100X40 | 2 | 1882 |

Diana 40 (360x550)

Wall 2

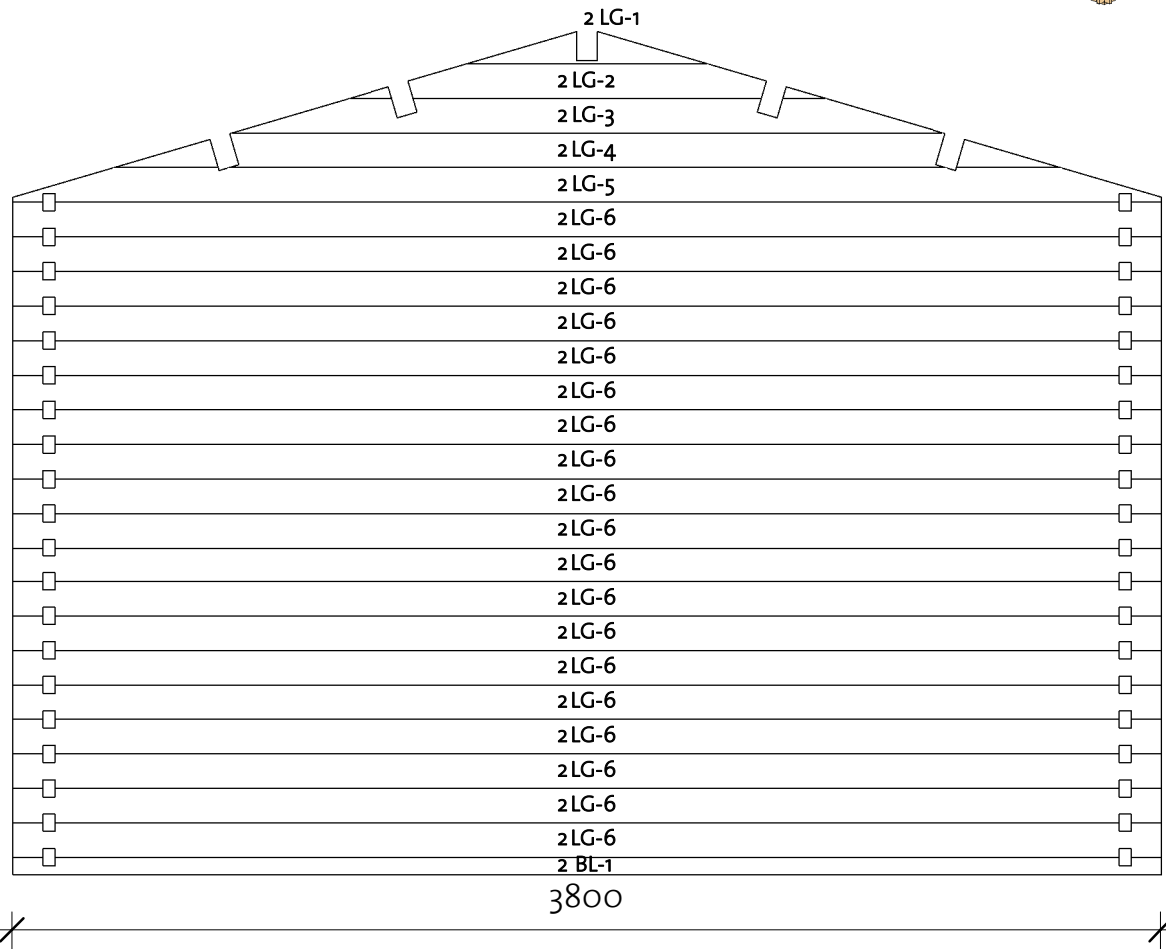
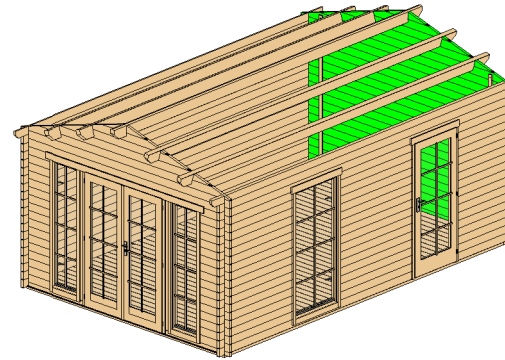

| Wall 2 | | | |
|--------|---------|-------|------------|
| Mark | Profile | Count | Cut Length |

| | | | |
|--------|--------|----|------|
| 2BL-1 | 40x57 | 1 | 3800 |
| 2LG-1* | 40x114 | 1 | 791 |
| 2LG-2* | 40x114 | 1 | 1571 |
| 2LG-3* | 40x114 | 1 | 2351 |
| 2LG-4* | 40x114 | 1 | 3130 |
| 2LG-5* | 40x114 | 1 | 3800 |
| 2LG-6 | 40x114 | 19 | 3800 |

* Gable - delivered premounted

| Log Profile Wall 2 | |
|--------------------|---------|
| Profile | Profile |

| | |
|--------|--|
| 40x57 | |
| 40x114 | |

Diana 40 (360x550)

Wall B

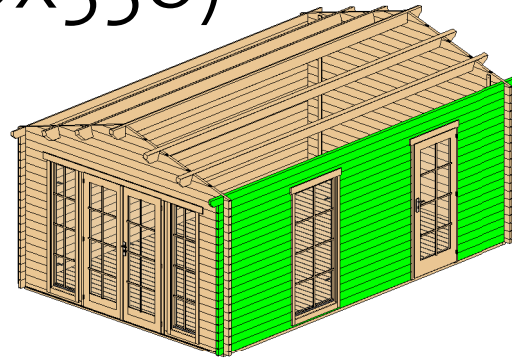

| Log Profile Wall B | |
|--------------------|---------|
| Profile | Profile |

| | |
|--------|--|
| 40X114 | |
| 40X114 | |

| Wall B | | | |
|--------|---------|-------|------------|
| Mark | Profile | Count | Cut Length |

| | | | |
|-------|--------|----|------|
| BLG-1 | 40X114 | 17 | 1102 |
| BLG-2 | 40X114 | 16 | 1429 |
| BLG-3 | 40X114 | 16 | 1435 |
| BLG-4 | 40X114 | 1 | 3748 |
| BLG-5 | 40X114 | 1 | 5700 |
| BLG-6 | 40X114 | 1 | 5700 |
| BTL-1 | 40X114 | 1 | 5980 |

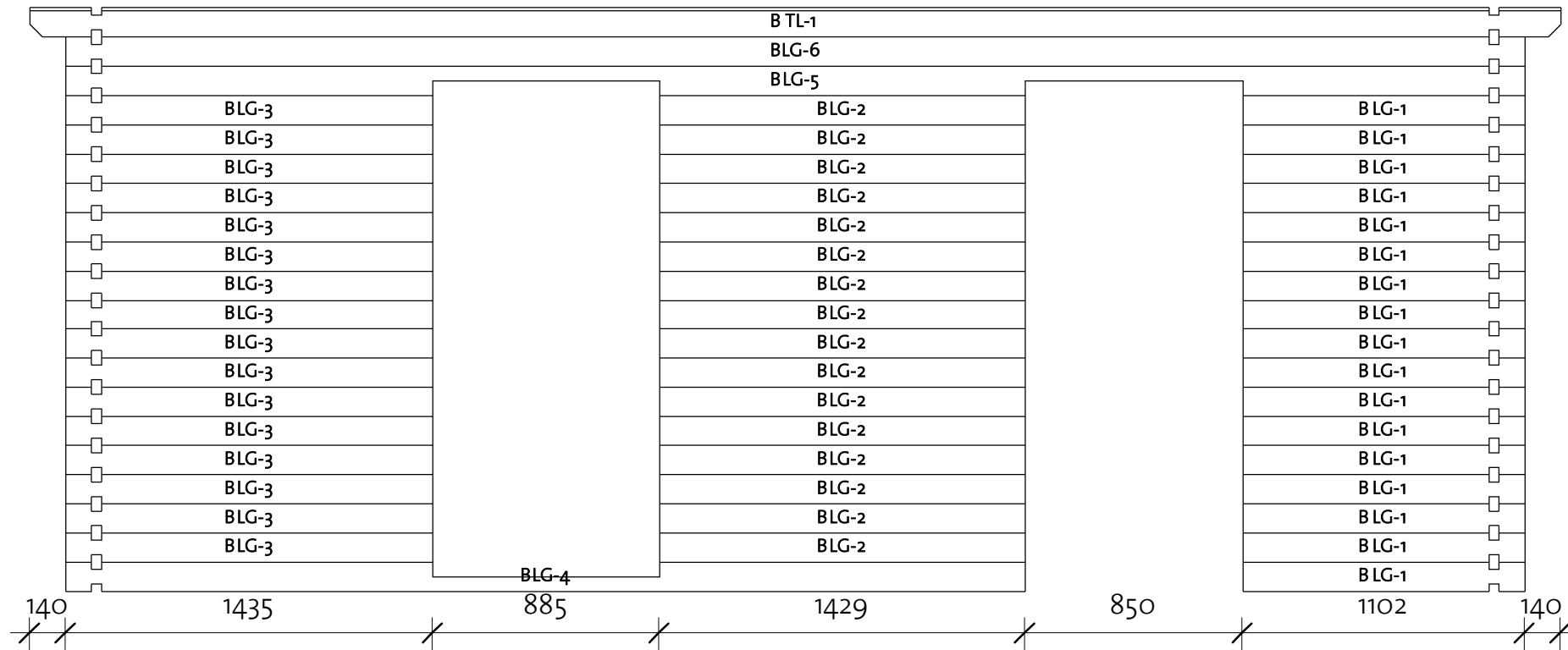

Diana 40 (360x550)

Roof 1

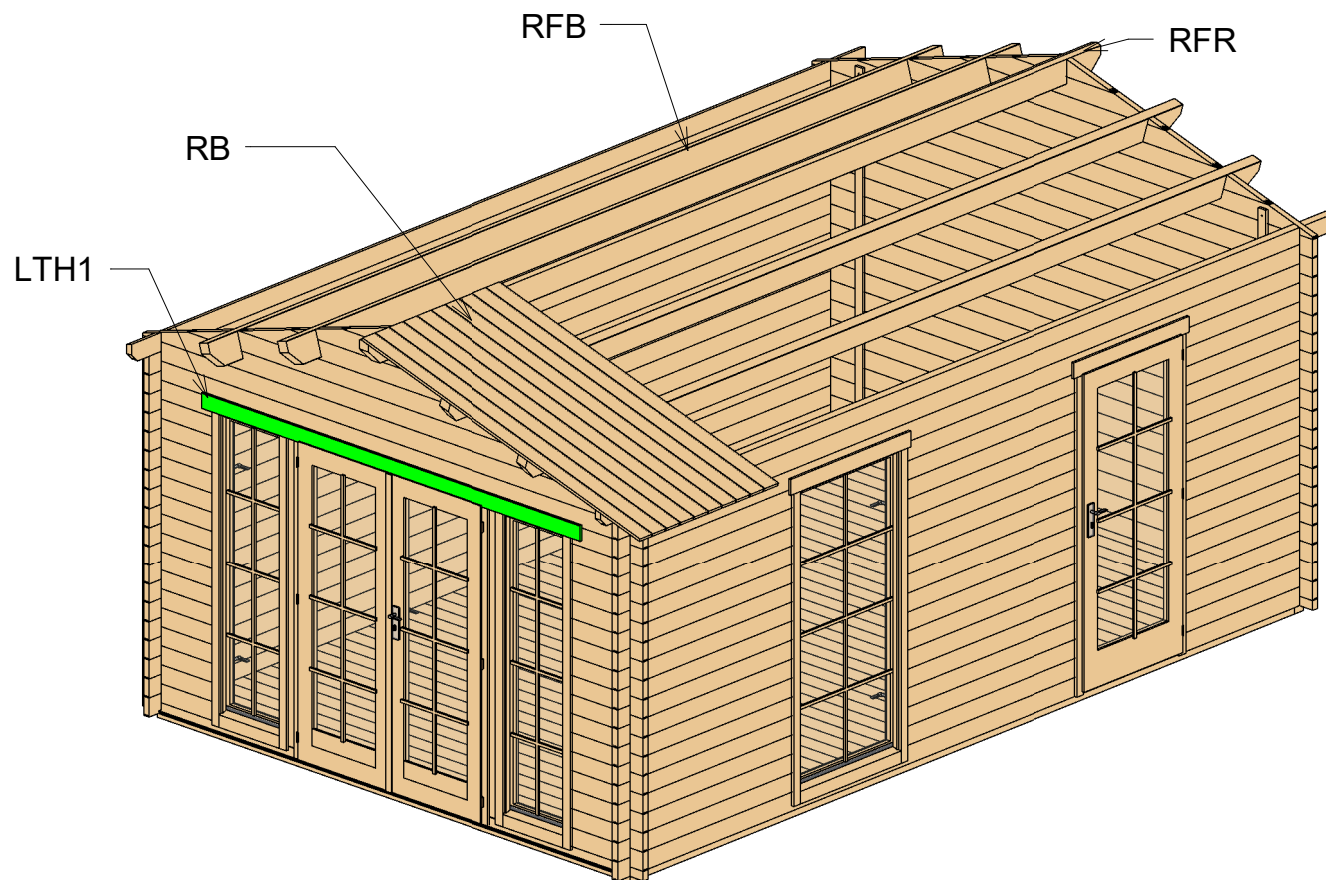

| Roof | | | | |
|------|-----------------|---------|-------|--------|
| Mark | Type | Profile | Count | Length |
| RFR | Ridge 68x160 | | 1 | 5980 |
| RFB | Beam 68x160 | | 4 | 5980 |
| RB | 17x114 | | 108 | 2200 |

| Lath list | | | | |
|-----------|-------|---------|-------|--------|
| Mark | Type | Profile | Count | Length |
| LTH1 | 18x95 | | 2 | 2875 |

Diana 40 (360x550)

Roof 2

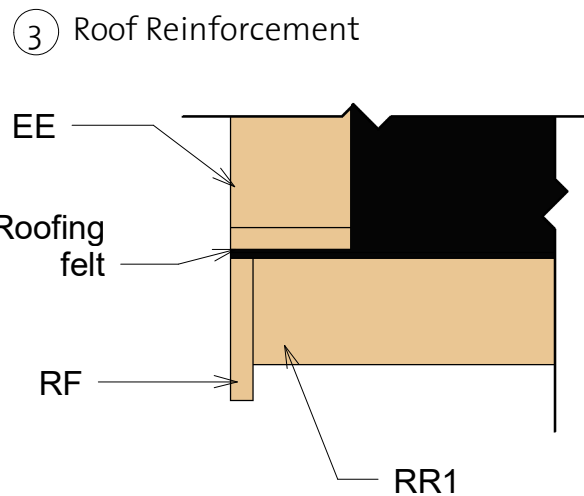
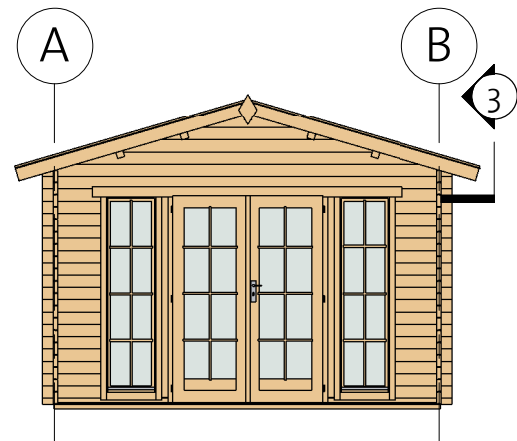
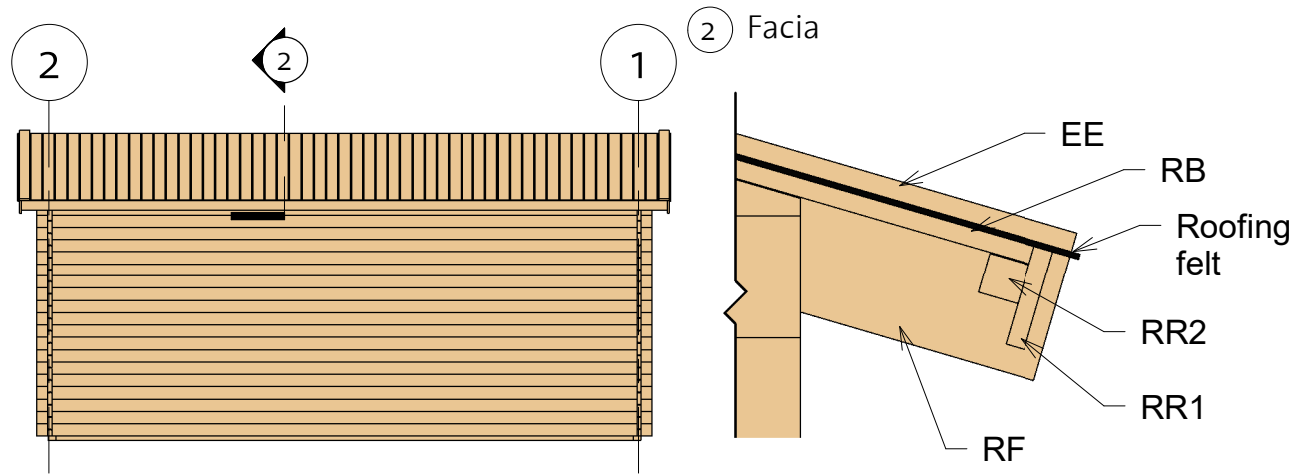

| Fascia Schedule | | | | |
|-----------------|-----------------------------|---------|-------|--------|
| Mark | Type | Profile | Count | Length |
| EE | Eave Edging 18x95 | | 4 | 2240 |
| RF | Roof Fascia 18x120 | | 4 | 2240 |
| RR1 | Roof reinforcement 18x95 | | 2 | 5980 |
| RR2 | Roof reinforcement 38x38 | | 2 | 5980 |

Diana 40 (360x550)

Extras

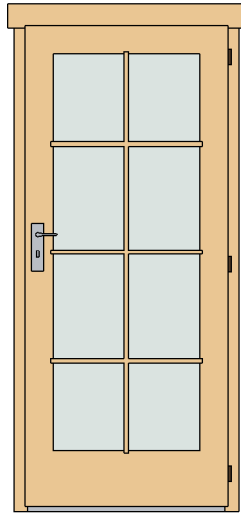
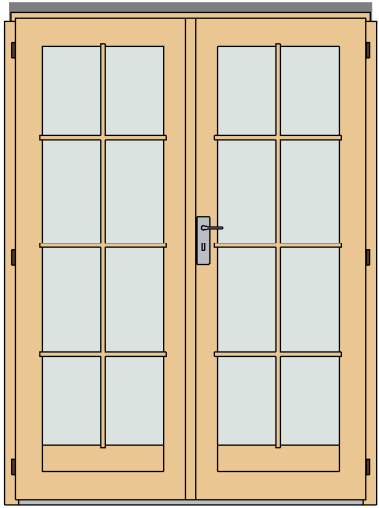

| Door Schedule | | | | |
|---------------|---|-------|--------|-------|
| Mark | Type | Width | Height | Count |
| CD6R | Classic door 6, full glass right | 840 | 1955 | 1 |
| CDD3R | Classic double door 3, full glass right | 1425 | 1955 | 1 |



| Family | Count |
|--------|-------|
| Romb | 2 |

| Type | Count | Length |
|-----------------|-------|--------|
| Windboard 18x40 | 4 | 2220 |

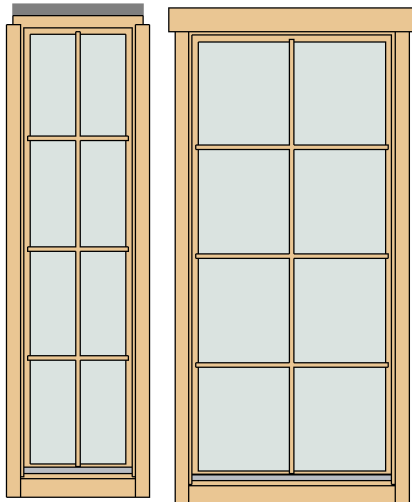



| Window Schedule | | | | |
|-----------------|------------------------------------|-------|--------|-------|
| Mark | Type | Width | Height | Count |
| CW3L | Classic window 3, full glass left | 515 | 1890 | 1 |
| CW3R | Classic window 3, full glass right | 515 | 1890 | 1 |
| CW4R | Classic window 4, right | 875 | 1890 | 1 |
| WCB8 | Windows Crossbar 8 | -- | -- | 1 |

| Fasteners & Extras | | |
|--------------------|------------|-------|
| Name | Type | Count |
| Hitblock | 300-400 mm | |
| Screws | 5,0 x 70 | 10 |
| Bolts | M8 x 70 | 12 |
| Nails | 1,4 x 40 | 45 |
| Screws | 6,0 x 140 | 60 |
| Screws | 4,0 x 40 | 130 |
| Screws | 4.0 x 50 | 900 |



Diana 40 (360x550)

List of all items 1



Impregnated foundation beams

| Mark | Type | Profile | Count | Length |
|------|--------------|---|-------|--------|
| IFB1 | IFB 70x40 |  | 8 | 5350 |
| IFB2 | IFB 70x40 |  | 2 | 3590 |





Floor Schedule

| Mark | Type | Profile | Count | Length |
|------|-------------|---|-------|--------|
| FB | FB 17x114 |  | 49 | 3517 |
| BB1 | BB 20x40 |  | 2 | 3600 |
| BB2 | BB 20x40 | | 2 | 5500 |

Roof

| Mark | Type | Profile | Count | Length |
|------|-----------------|---|-------|--------|
| RFR | Ridge 68x160 |  | 1 | 5980 |
| RFB | Beam 68x160 |  | 4 | 5980 |
| RB | 17x114 |  | 108 | 2200 |

Fascia Schedule

| Mark | Type | Profile | Count | Length |
|------|--------------------------------|---|-------|--------|
| EE | Eave Edging 18x95 |  | 4 | 2240 |
| RF | Roof Fascia 18x120 |  | 4 | 2240 |
| RR1 | Roof reinforcement 18x95 |  | 2 | 5980 |
| RR2 | Roof reinforcement 38x38 |  | 2 | 5980 |

Diana 40 (360x550)

List of all items 2

| Wall 1 | | | |
|--------|---------|-------|------------|
| Mark | Profile | Count | Cut Length |

| | | | |
|--------|--------|----|------|
| 1BL-1 | 40x57 | 2 | 1180 |
| 1LG-1 | 40x114 | 34 | 560 |
| 1LG-2* | 40x114 | 1 | 791 |
| 1LG-3* | 40x114 | 1 | 1571 |
| 1LG-4* | 40x114 | 1 | 2351 |
| 1LG-5* | 40x114 | 1 | 3130 |
| 1LG-6* | 40x114 | 1 | 3800 |
| 1LG-7 | 40x114 | 2 | 3800 |



| Wall A | | | |
|--------|---------|-------|------------|
| Mark | Profile | Count | Cut Length |

| | | | |
|-------|--------|----|------|
| ALG-1 | 40x114 | 19 | 5700 |
| ATL-1 | 40x114 | 1 | 5980 |

| Lath list | | | | |
|-----------|------|---------|-------|--------|
| Mark | Type | Profile | Count | Length |

| | | | | |
|------|-------|---|---|------|
| LTH1 | 18x95 |  | 2 | 2875 |
|------|-------|---|---|------|

| Log Profiles | |
|--------------|---------|
| Profile | Profile |

| | |
|--------|---|
| 40x57 |  |
| 40x114 |  |

| Wall 2 | | | |
|--------|---------|-------|------------|
| Mark | Profile | Count | Cut Length |

| | | | |
|--------|--------|----|------|
| 2BL-1 | 40x57 | 1 | 3800 |
| 2LG-1* | 40x114 | 1 | 791 |
| 2LG-2* | 40x114 | 1 | 1571 |
| 2LG-3* | 40x114 | 1 | 2351 |
| 2LG-4* | 40x114 | 1 | 3130 |
| 2LG-5* | 40x114 | 1 | 3800 |
| 2LG-6 | 40x114 | 19 | 3800 |

* Gable - delivered premounted

| Wall B | | | |
|--------|---------|-------|------------|
| Mark | Profile | Count | Cut Length |

| | | | |
|-------|--------|----|------|
| BLG-1 | 40x114 | 17 | 1102 |
| BLG-2 | 40x114 | 16 | 1429 |
| BLG-3 | 40x114 | 16 | 1435 |
| BLG-4 | 40x114 | 1 | 3748 |
| BLG-5 | 40x114 | 1 | 5700 |
| BLG-6 | 40x114 | 1 | 5700 |
| BTL-1 | 40x114 | 1 | 5980 |

| Columns | | | |
|---------|---------|-------|--------|
| Mark | Profile | Count | Length |

| | | | |
|-----|-------------|---|------|
| CM1 | Post 100x40 | 2 | 1882 |
|-----|-------------|---|------|

| Log Profiles | |
|--------------|---------|
| Profile | Profile |

| | |
|--------|---|
| 40x114 |  |
|--------|---|