

Fredrikstad 40 (450x300)

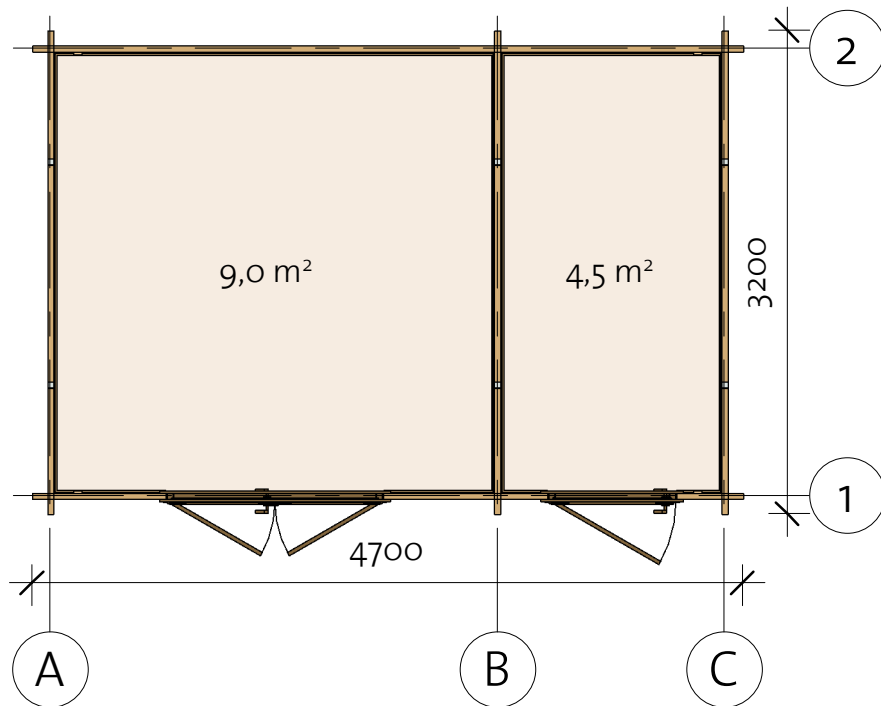
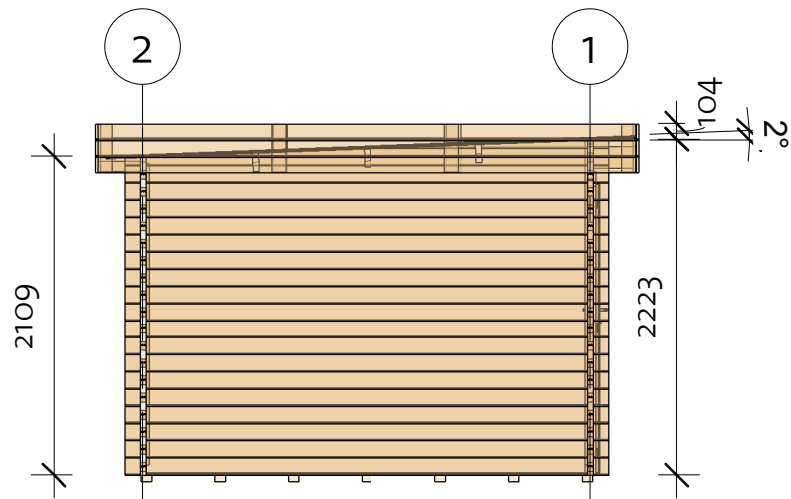

4200007_200612

 **VIKTRÄ**

Fredrikstad 40 (450x300)

Foundation

Impregnated foundation beams				
Mark	Type	Profile	Count	Length
IFB	IFB 70x40		7	4490

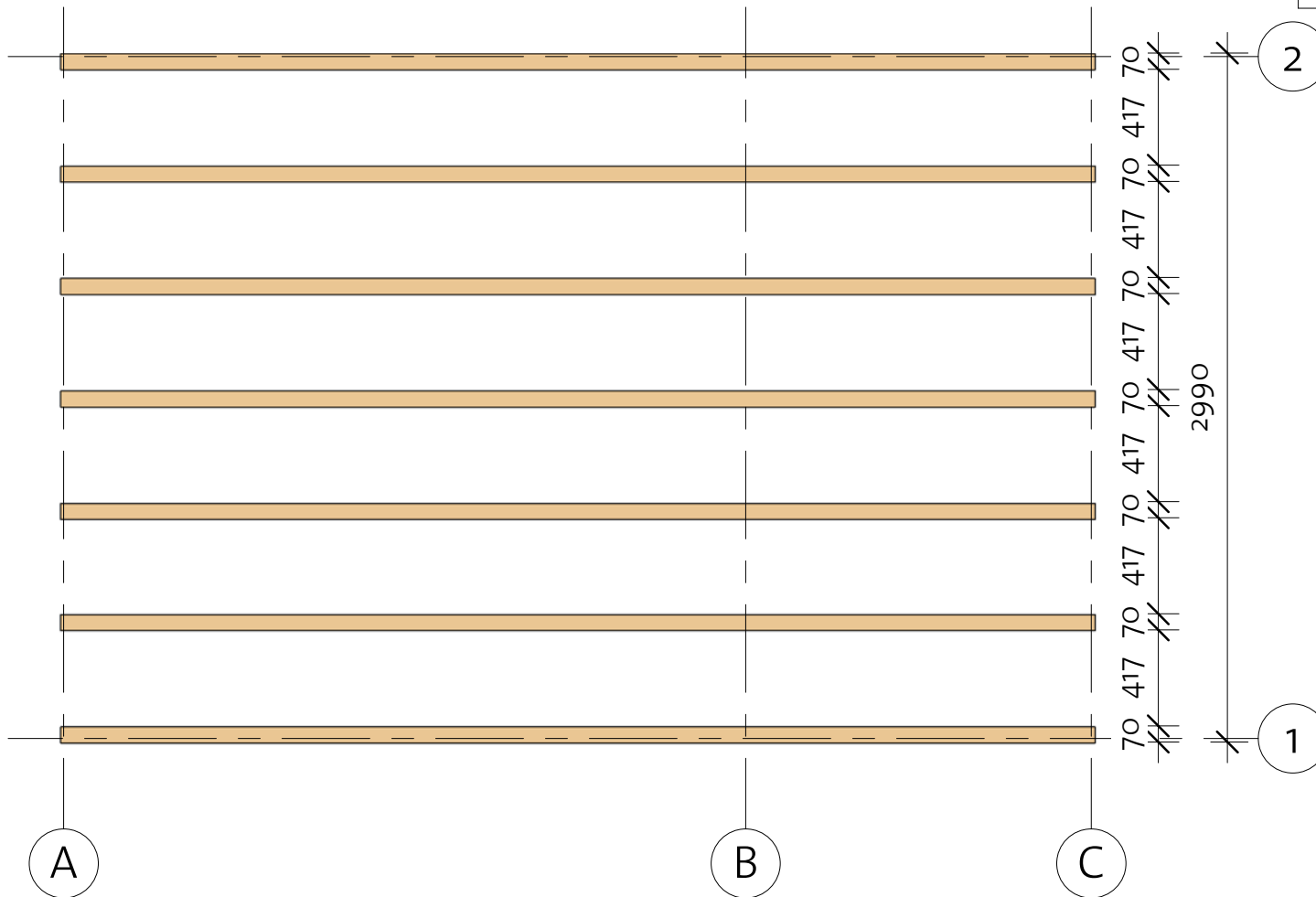

4200007_190228

Fredrikstad 40 (450x300)

Floor Plan

① Baseboard

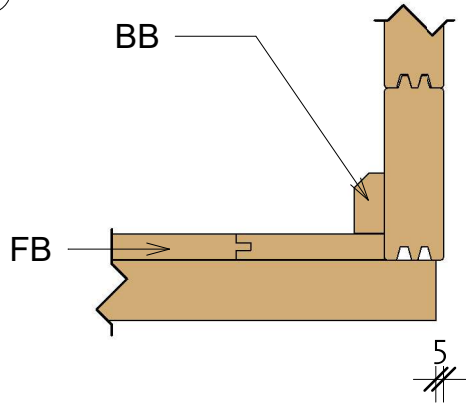

Floor Schedule

Mark	Type	Profile	Count	Length
------	------	---------	-------	--------

FB	FB 17x114		40	2916
----	-----------	---	----	------

BB1	BB 20x40		4	3000
BB2	BB 20x40		2	4500

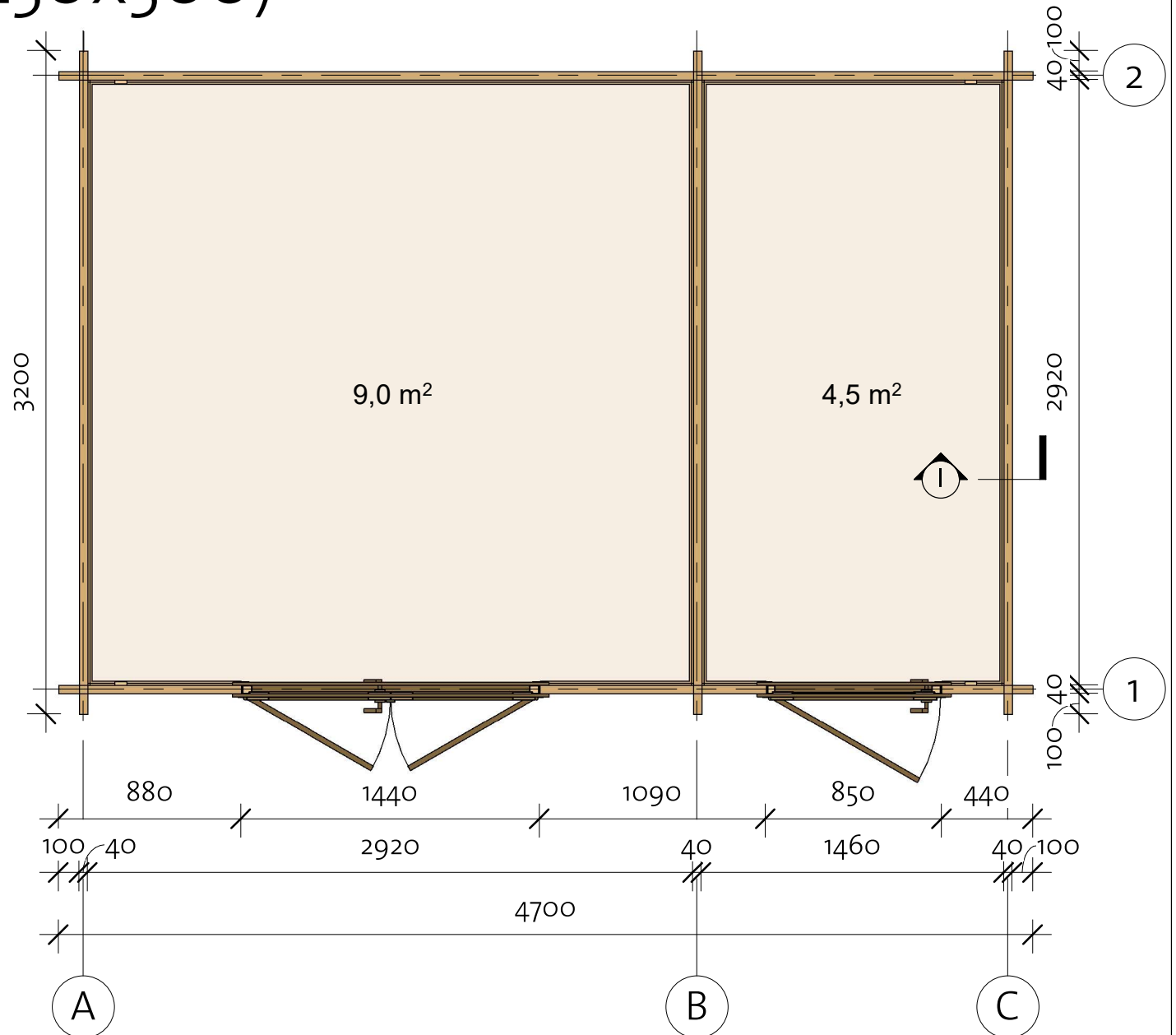

Fredrikstad 40 (450x300)

Wall 2

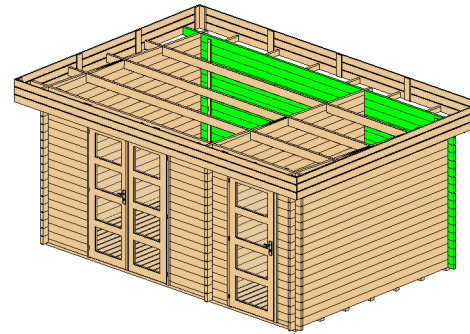

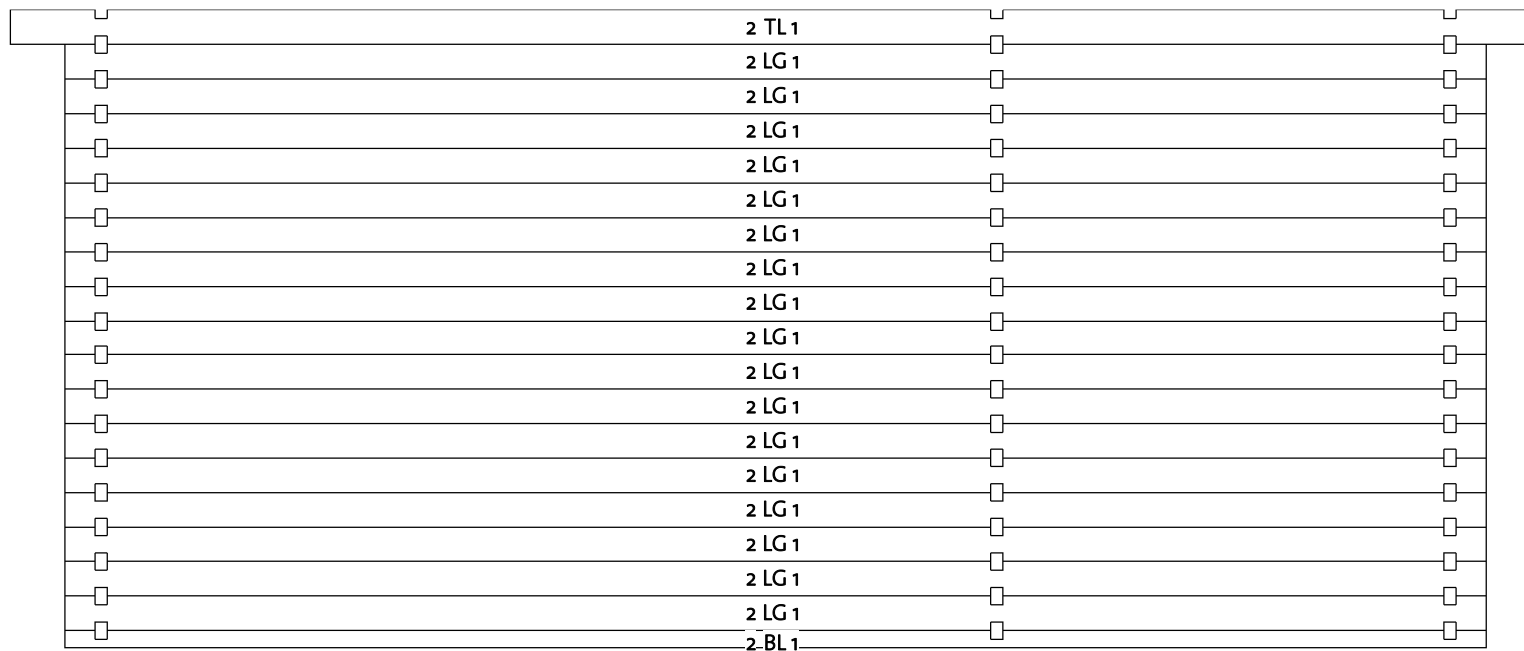

Wall 2			
Mark	Profile	Count	Cut Length

2BL 1	40X57	1	4700
2LG 1	40X114	17	4700
2TL 1	40X114	1	5060

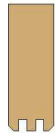

Log Profile Wall 2	
Profile	Profile

40X57	
40X114	
40X114	

180
4200007_200612

4700

180

Fredrikstad 40 (450x300)

Wall A

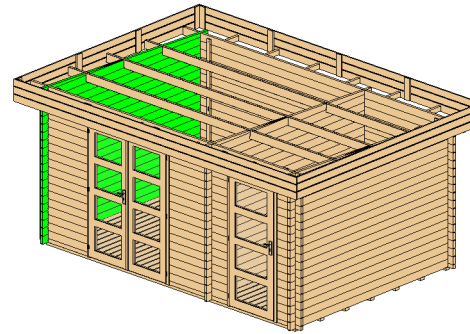

Wall A			
Mark	Profile	Count	Cut Length
ALG 1*	40x114	1	1577
ALG 2*	40x114	1	3200
ALG 3	40x114	18	3200

* Gable - delivered premounted

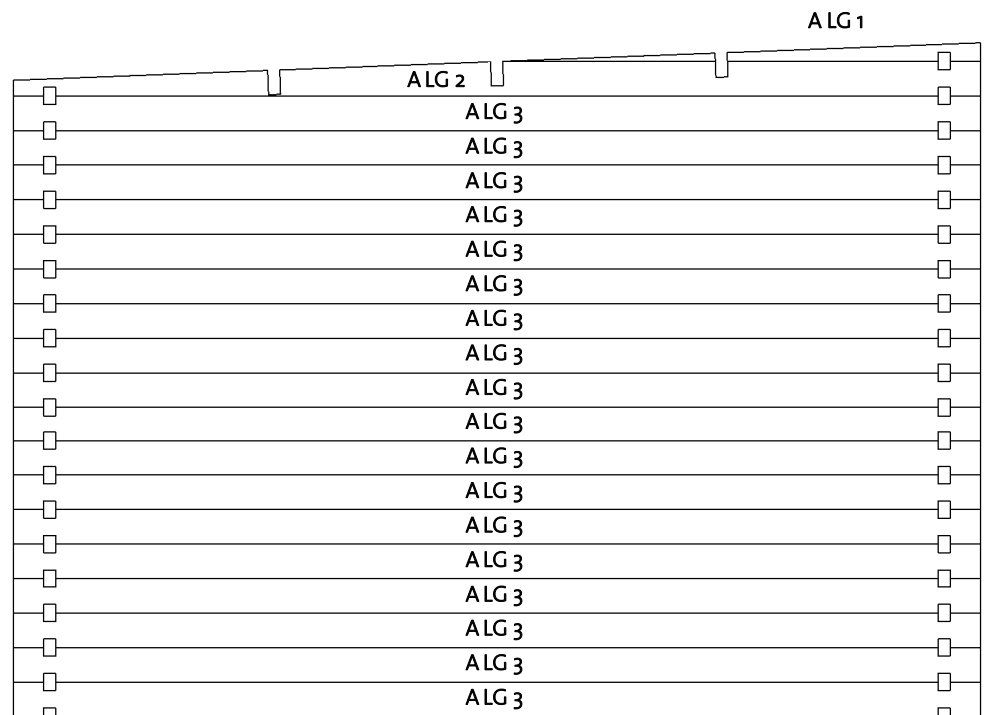

3200

Log Profile Wall A	
Profile	Profile

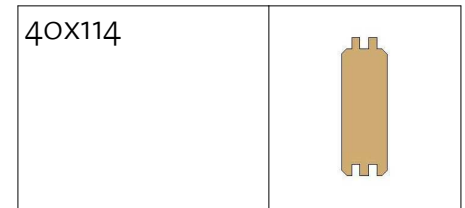

Fredrikstad 40 (450x300)

Wall C

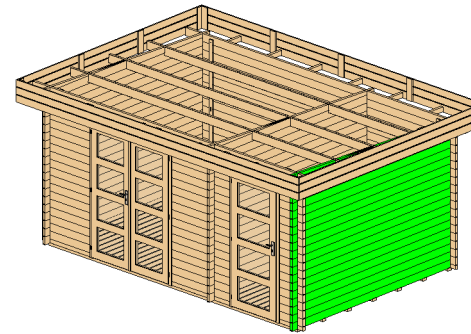

Wall C			
Mark	Profile	Count	Cut Length
CLG 1*	40x114	1	1577
CLG 2*	40x114	1	3200
CLG 3	40x114	18	3200

* Gable - delivered premounted

CLG 1

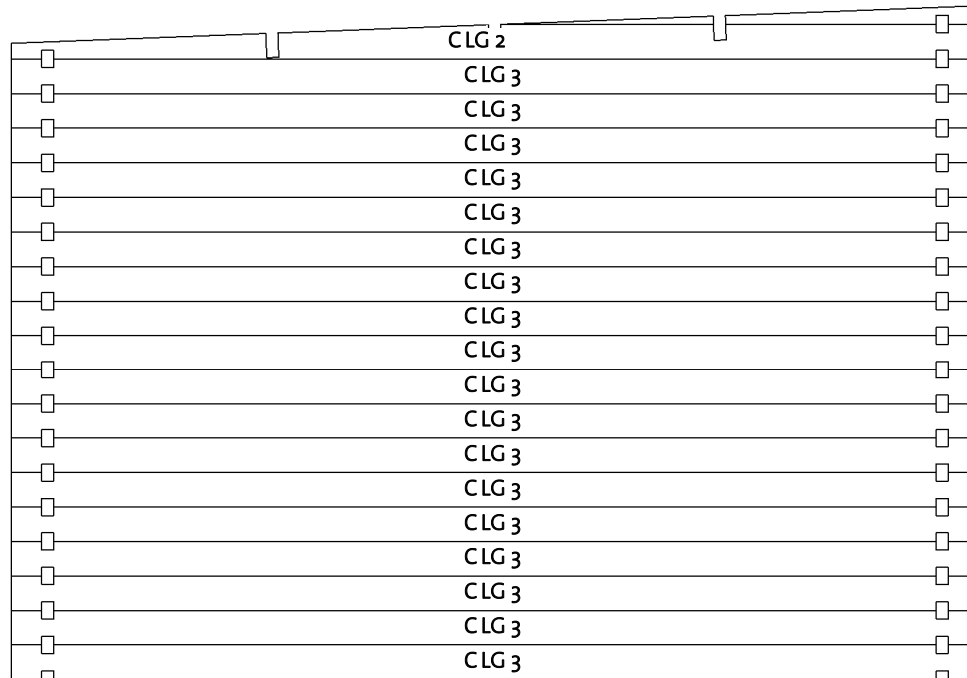

3200

4200007_200612

Log Profile Wall C

Profile

Profile



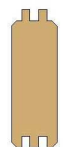

40x114

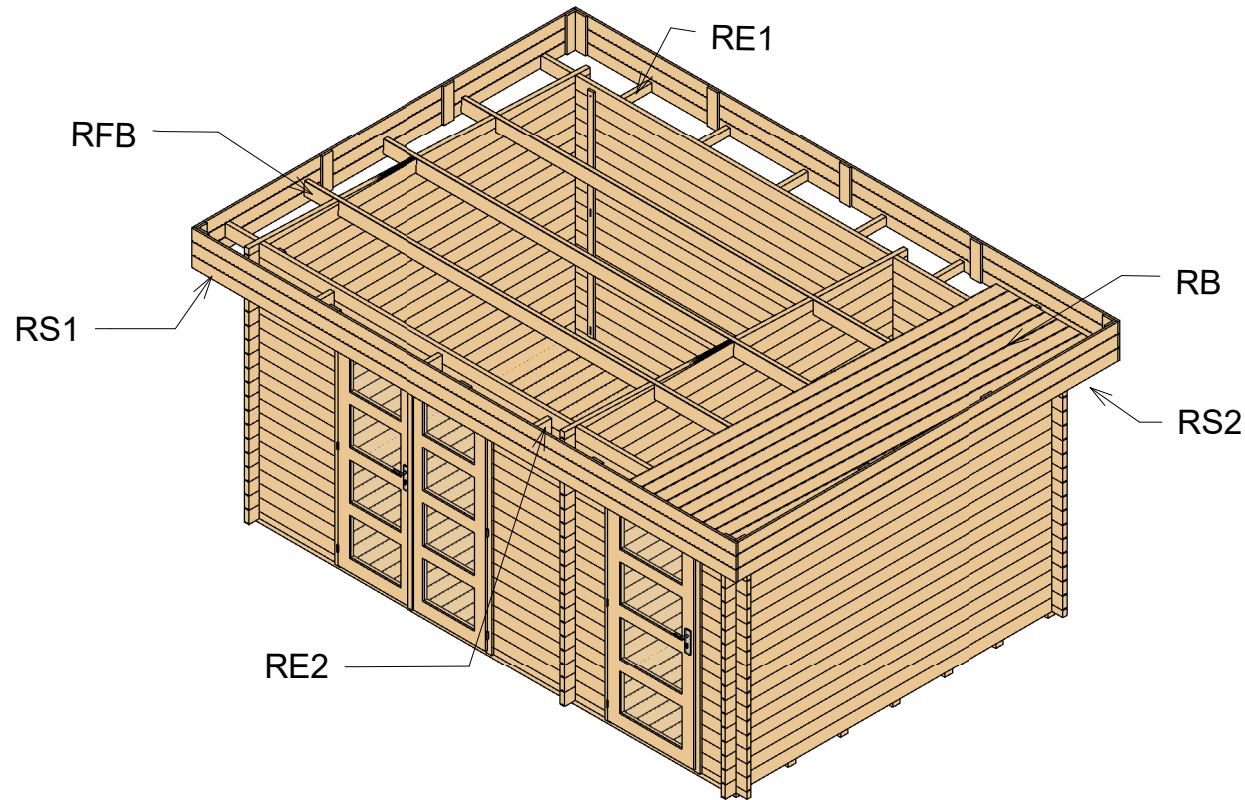

Fredrikstad 40 (450x300)

Roof 1

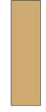



Roof				
Mark	Type	Profile	Count	Length
RB	17x114		46	3510
RE1	40x70		6	280
RE2	40x143		4	280
RFB	Beam 40x120		3	5060

Roof Side Schedule

Type	Length	Count
RS1	5094	2
RS2	3560	2

Fredrikstad 40 (450x300)

Mark	Type	Profile	Count	Length
------	------	---------	-------	--------

EE1	Eave Edging 18x40		2	2512
EE2	Eave Edging 18x40		2	3470

Roof 2

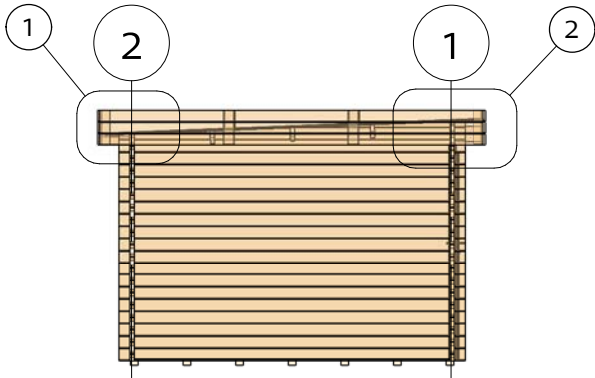

1 Roof - Callout Back

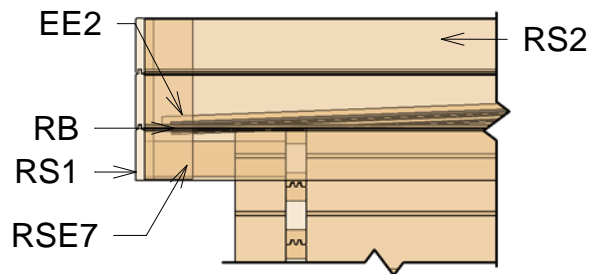

2 Roof - Callout Front

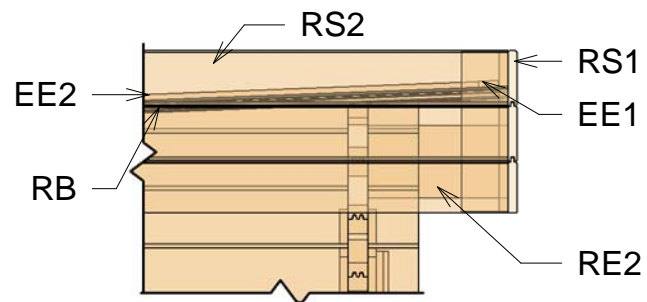

4200007_190228

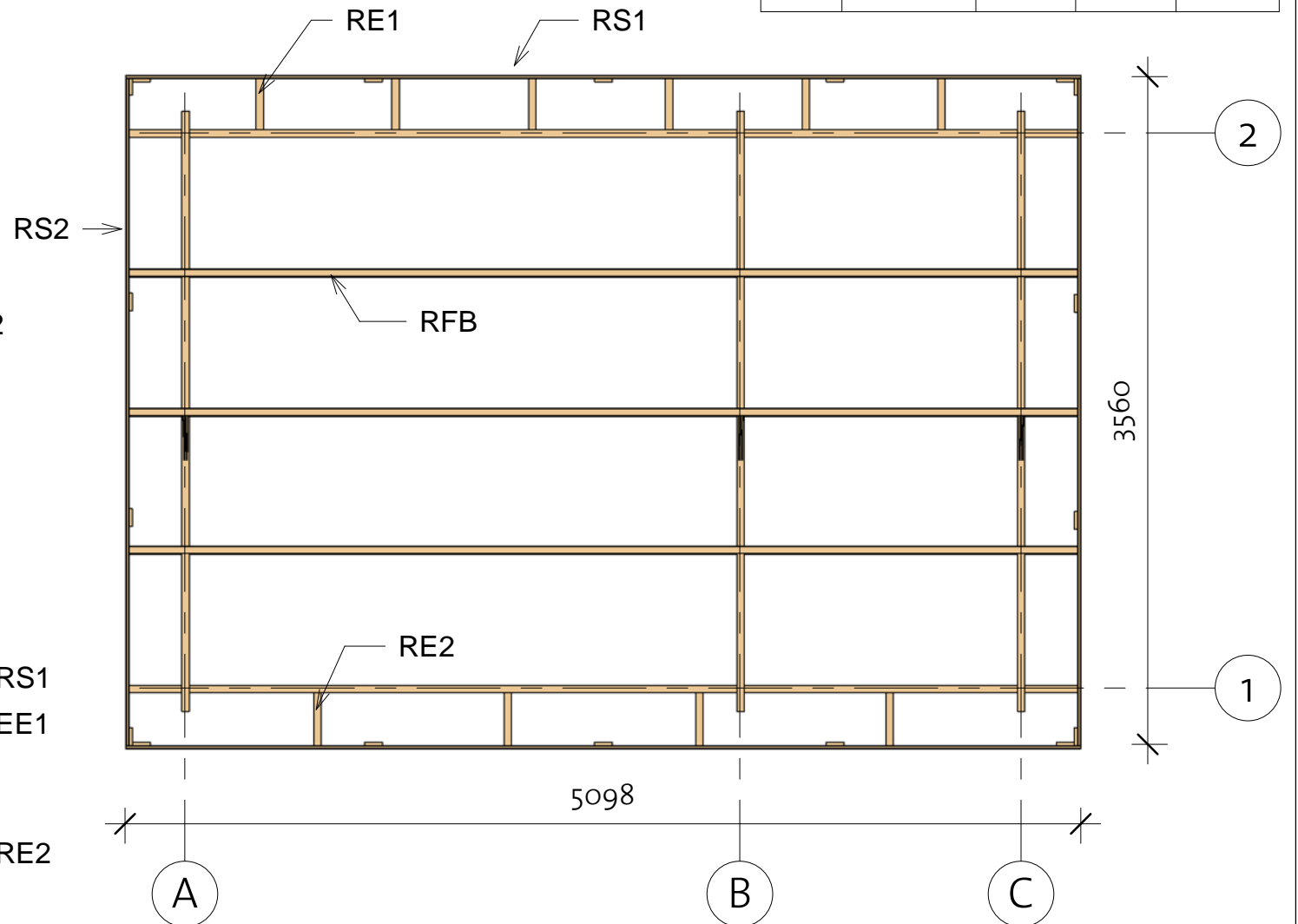

Fredrikstad 40 (450x300)

Extras

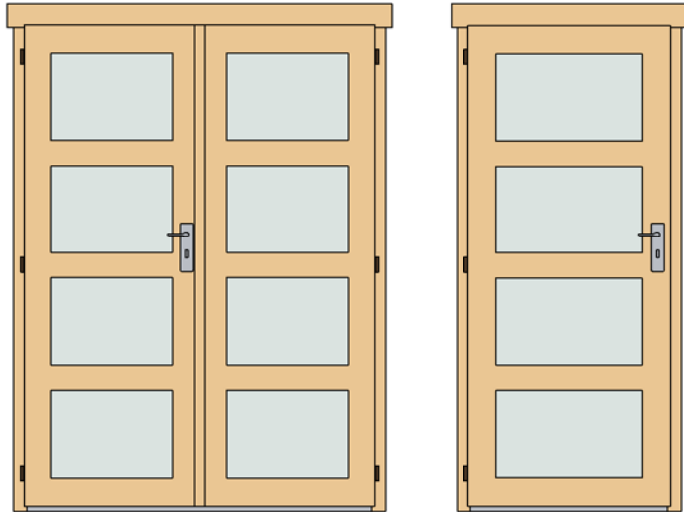

Door Schedule				
Model	Type	Width	Height	Count
CD2L	Classic door 2, four glass left	840	1955	1
CDD2L	Classic double door 2, four glass left	1425	1955	1

Fasteners & Extras		
Name	Type	Count

Hitblock	300-400 mm	
Bolts	M8 x 70	12
Screws	5,0 x 70	20
Nails	1,4 x 40	50
Screws	6,0 x 140	120
Screws	4,0 x 50	600



Windboard		
Type	Count	Length

Windboard1 18x40	2	2200
Windboard2 18x40	2	2200





Fredrikstad 40 (450x300)

List of all items 1



Impregnated foundation beams

Mark	Type	Profile	Count	Length
IFB	IFB 70x40		7	4490

Roof

Mark	Type	Profile	Count	Length
RB	17x114		46	3510
RE1	40x70		6	280
RE2	40x143		4	280
RFB	Beam 40x120		3	5060

Mark	Type	Profile	Count	Length
------	------	---------	-------	--------

EE1	Eave Edging 18x40		2	2512
EE2	Eave Edging 18x40		2	3470

Floor Schedule

Mark	Type	Profile	Count	Length
FB	FB 17x114		40	2916

BB1	BB 20x40		4	3000
BB2	BB 20x40		2	4500

Roof Side Schedule

Type	Length	Count
RS1	5094	2
RS2	3560	2

Fredrikstad 40 (450x300)

List of all items 2



Wall 1			
Mark	Profile	Count	Cut Length

1BL 1	40X57	1	440
1BL 2	40X57	1	880
1BL 3	40X57	1	1090
1LG 1	40X114	17	440
1LG 2	40X114	17	880
1LG 3	40X114	17	1090
1LG 4	40X114	1	4700
1TL 1	40X114	1	5060

Wall B			
Mark	Profile	Count	Cut Length

BLG 1 *	40X114	1	1577
BLG 2 *	40X114	1	3200
BLG 3	40X114	18	3200

Log Profiles	
Profile	Profile

40X57	
40X114	
40X114	

Wall 2			
Mark	Profile	Count	Cut Length

2BL 1	40X57	1	4700
2LG 1	40X114	17	4700
2TL 1	40X114	1	5060

Wall A			
Mark	Profile	Count	Cut Length

ALG 1 *	40X114	1	1577
ALG 2 *	40X114	1	3200
ALG 3	40X114	18	3200

Wall C			
Mark	Profile	Count	Cut Length

CLG 1 *	40X114	1	1577
CLG 2 *	40X114	1	3200
CLG 3	40X114	18	3200

* Gable - delivered premounted