

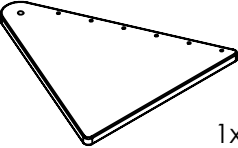

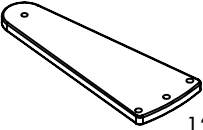







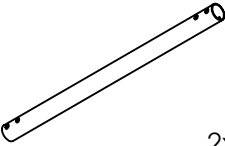
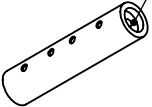
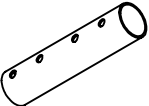
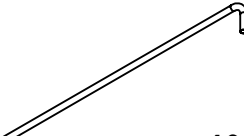
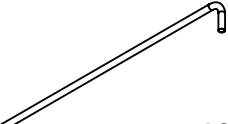
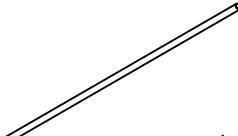
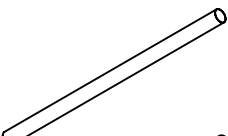
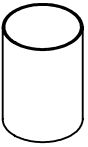
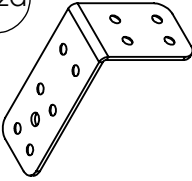

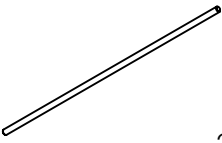

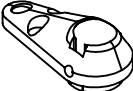





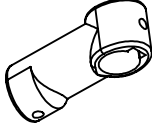
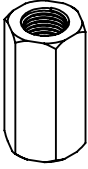

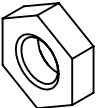



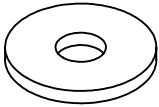
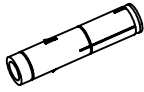
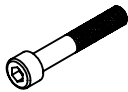
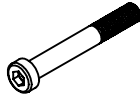

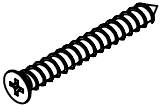

<p>P01</p>  <p>1x</p>	<p>P02</p>  <p>12x</p>	<p>P03a</p>  <p>1x</p>	<p>P04</p>  <p>2x</p>	<p>P05</p>  <p>M20</p> <p>1x</p>
<p>P06</p>  <p>1x</p>	<p>P07</p>  <p>13x</p> <p>∅ 22x1x1135mm</p>	<p>P08</p>  <p>12x</p> <p>∅ 22x1x1020mm</p>	<p>P09</p>  <p>6x</p> <p>∅ 22x1x840mm</p>	<p>P10</p>  <p>2x</p> <p>∅ 50x1x910mm</p>
<p>P11</p>  <p>13x</p> <p>∅ 127x179mm</p>	<p>P12a</p>  <p>2x</p>	<p>P13</p>  <p>1x</p> <p>∅ 100 mm</p>	<p>P14</p>  <p>2x</p> <p>M20x1000mm</p>	<p>P15</p>  <p>1x</p> <p>M8x1000mm</p>
<p>P16</p>  <p>104x</p>	<p>P17</p>  <p>38x</p>	<p>P18</p>  <p>6x</p>	<p>P19</p>  <p>6x</p>	<p>P20</p>  <p>4x</p>
<p>P21</p>  <p>3x</p> <p>∅ 35 mm</p>	<p>P22</p>  <p>26x</p> <p>∅ 22 mm</p>	<p>P23</p>  <p>12x</p> <p>∅ 10 mm</p>	<p>P24</p>  <p>25x</p>	<p>P25</p>  <p>1x</p> <p>M20 DIN 6334</p>
<p>P26</p>  <p>1x</p> <p>M20 DIN 934</p>	<p>P27</p>  <p>1x</p> <p>M20 DIN-EN 24035</p>	<p>P28</p>  <p>4x</p> <p>M8 DIN 934</p>	<p>P29</p>  <p>6x</p> <p>M5 DIN 934</p>	<p>P30</p>  <p>88x</p> <p>M6 DIN 562</p>

<p>(P31)</p>  <p>M10 \varnothing 30mm</p> <p>8x</p>	<p>(P33)</p>  <p>M8 x 55 mm</p> <p>4x</p>	<p>(P34)</p>  <p>M8x50 mm</p> <p>4x</p>	<p>(P35)</p>  <p>M8x55mm DIN6912</p> <p>8x</p>	<p>(P36)</p>  <p>M5 x 20 mm DIN 7991</p> <p>6x</p>
<p>(P37)</p>  <p>M6x6mm DIN914</p> <p>88x</p>	<p>(P38)</p>  <p>\varnothing 6x30mm</p> <p>8x</p>	<p>(P39)</p>  <p>\varnothing 6x50mm</p> <p>12x</p>	<p>(P40)</p>  <p>\varnothing 5x40mm</p> <p>114x</p>	<p>(P41)</p>  <p>\varnothing 4x25mm</p> <p>6x</p>
<p>(P42)</p>  <p>\varnothing 3,9x19mm</p> <p>12x</p>	<p>(P43)</p>  <p>8x</p>	<p>(P44)</p>  <p>M8 DIN 6334</p> <p>1x</p>	<p>(P45)</p>  <p>\varnothing 12 mm</p> <p>2x</p>	<p>(P46)</p>  <p>M8 x 80 mm</p> <p>1x</p>
<p>(P47)</p>  <p>M10 x 100 mm</p> <p>1x</p>	<p>(P48)</p>  <p>M10</p> <p>7x</p>	<p>(P49)</p>  <p>7x</p>	<p>(P50)</p>  <p>M10x70mm</p> <p>6x</p>	<p>(P51)</p>  <p>M8x14mm</p> <p>1x</p>
<p>(P52)</p>  <p>\varnothing 22x1x1100mm</p> <p>1x</p>				

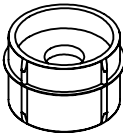

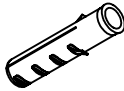
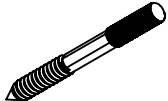
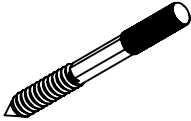
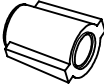
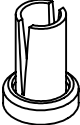
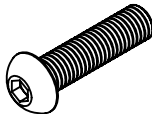
4

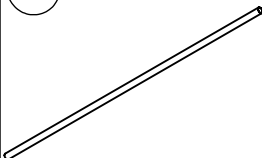
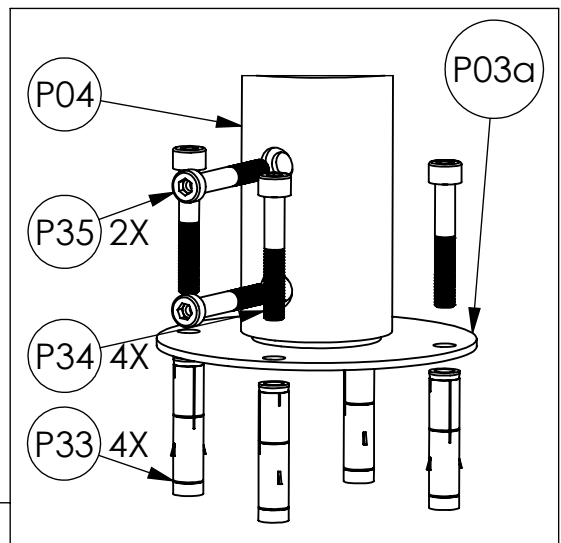
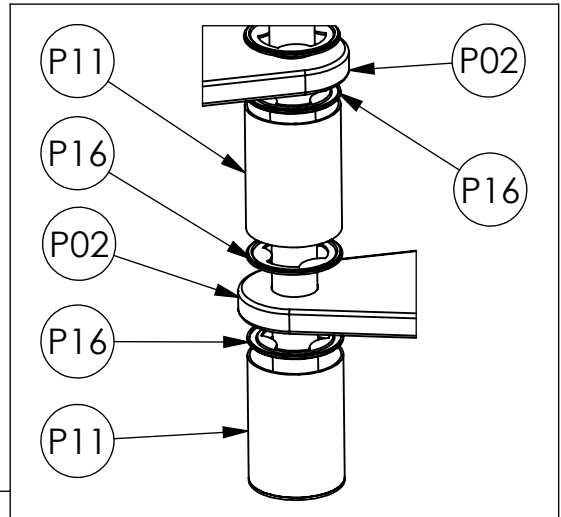
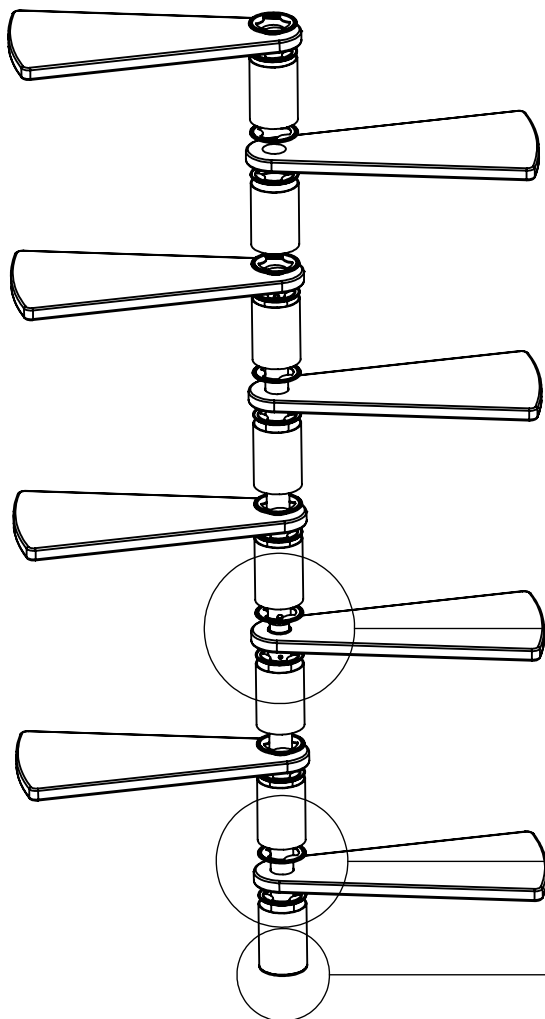
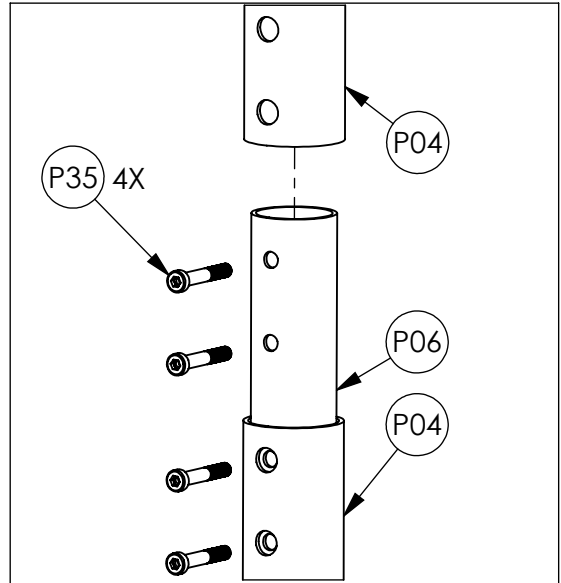
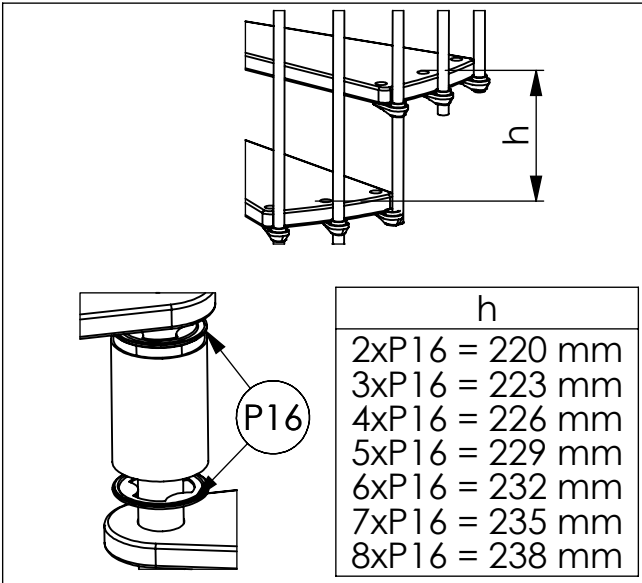
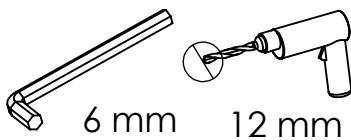

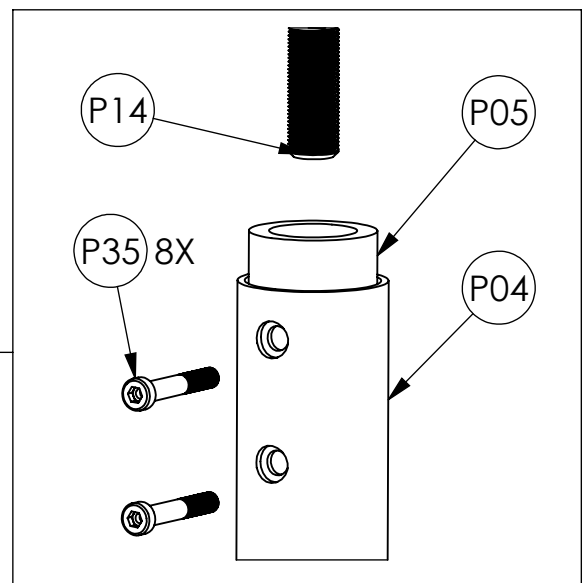
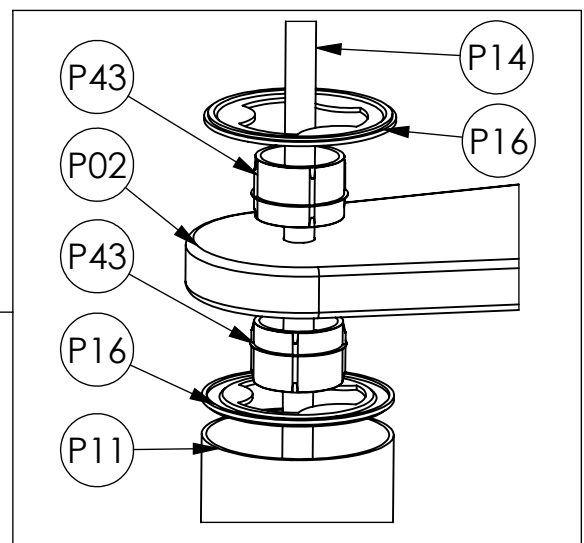
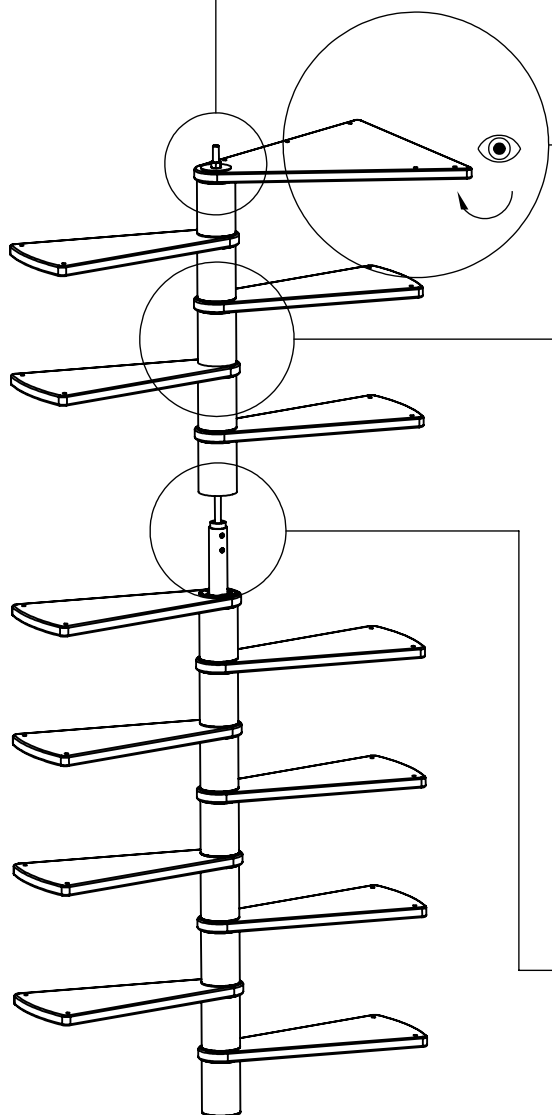
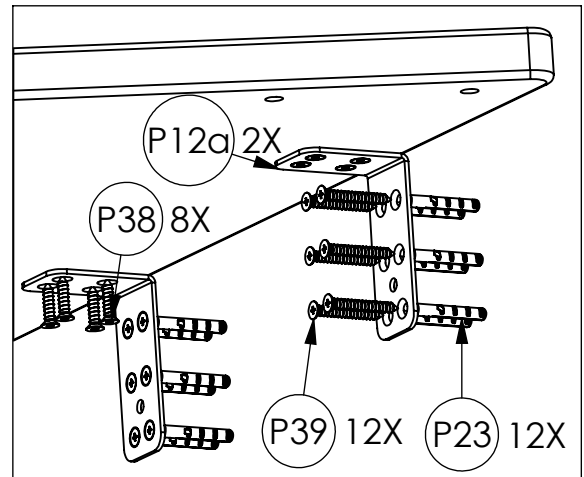
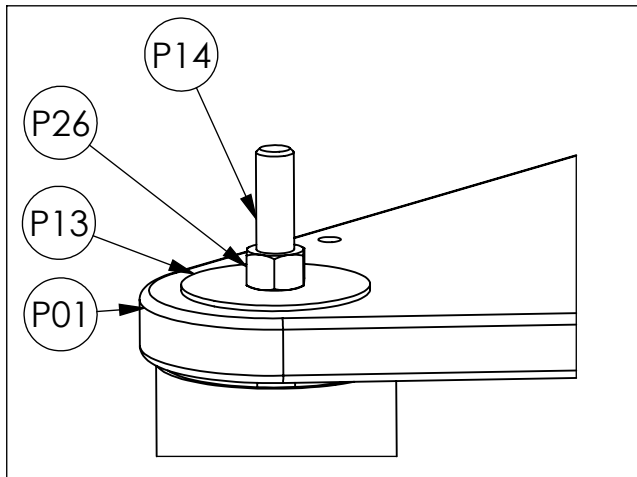

5



30 mm

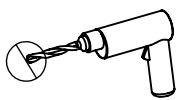

10 mm

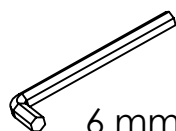

6 mm

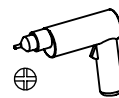

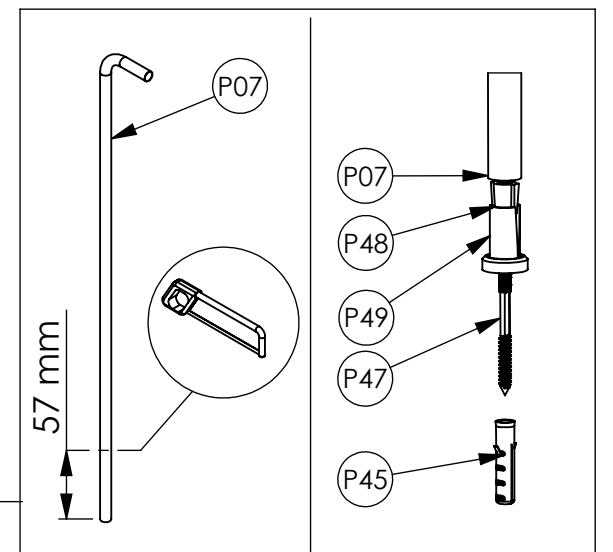
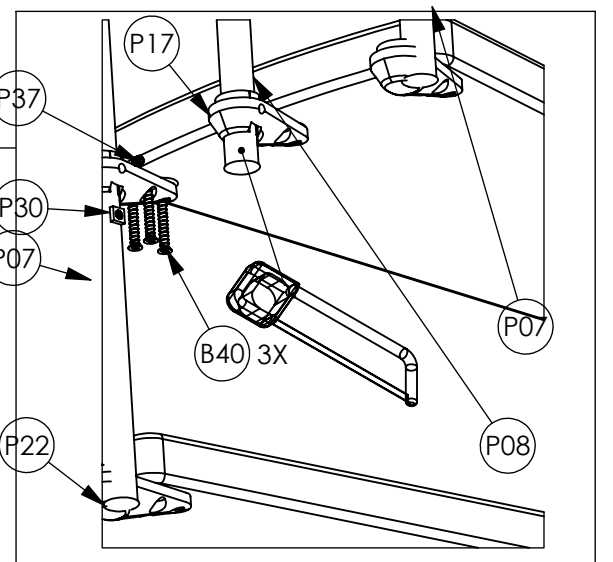
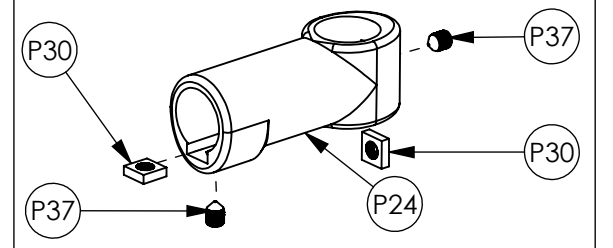
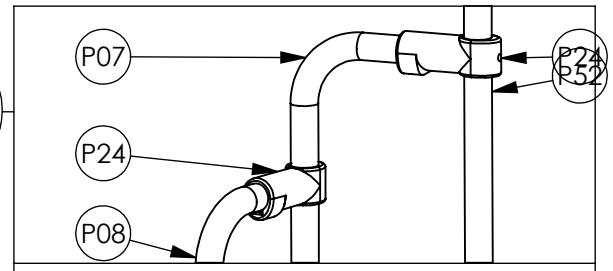
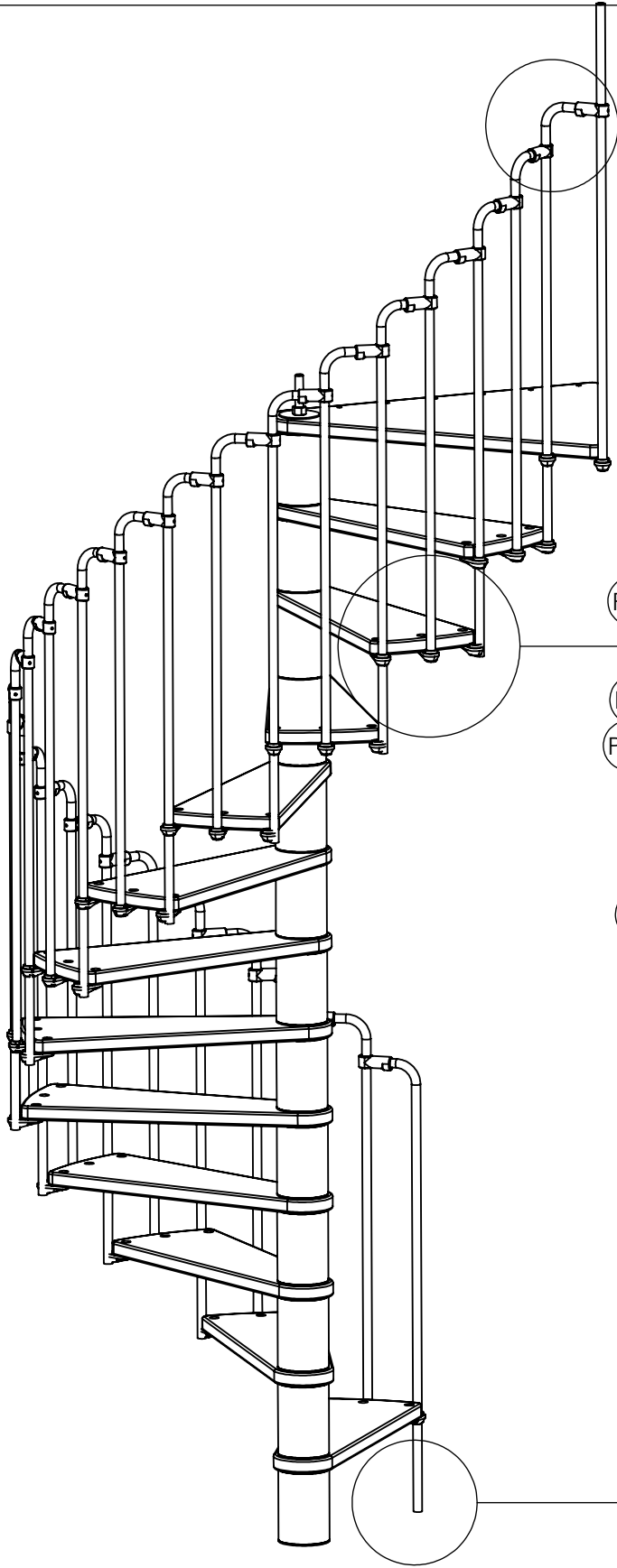

6

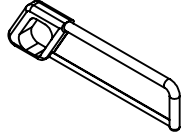
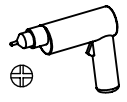

3 mm

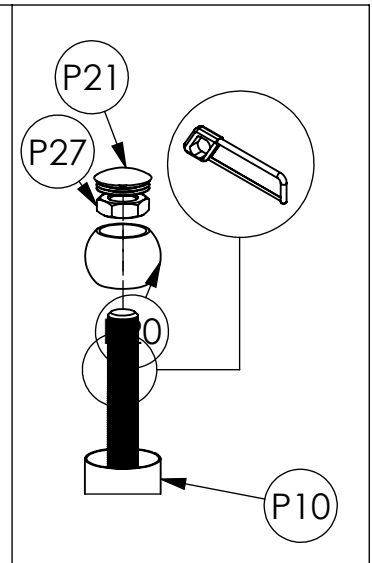
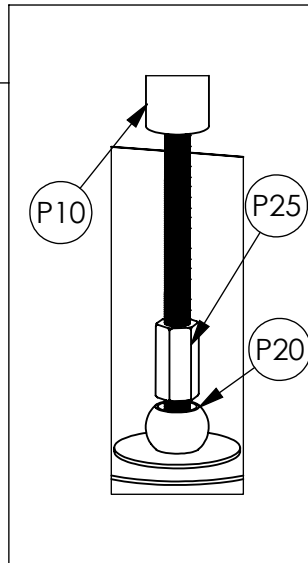
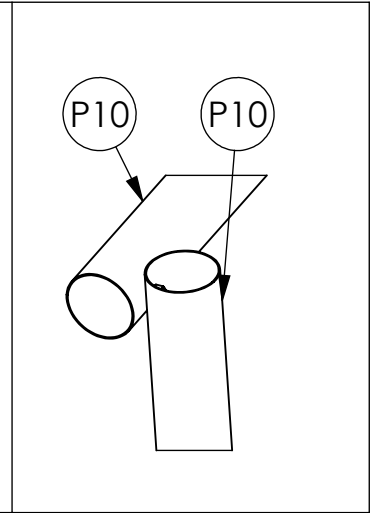
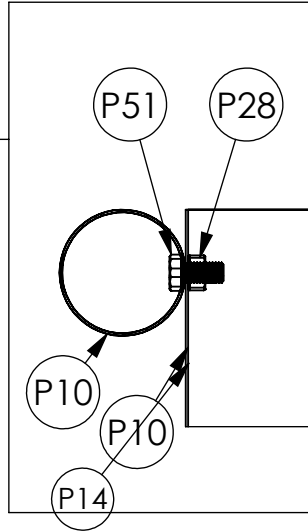
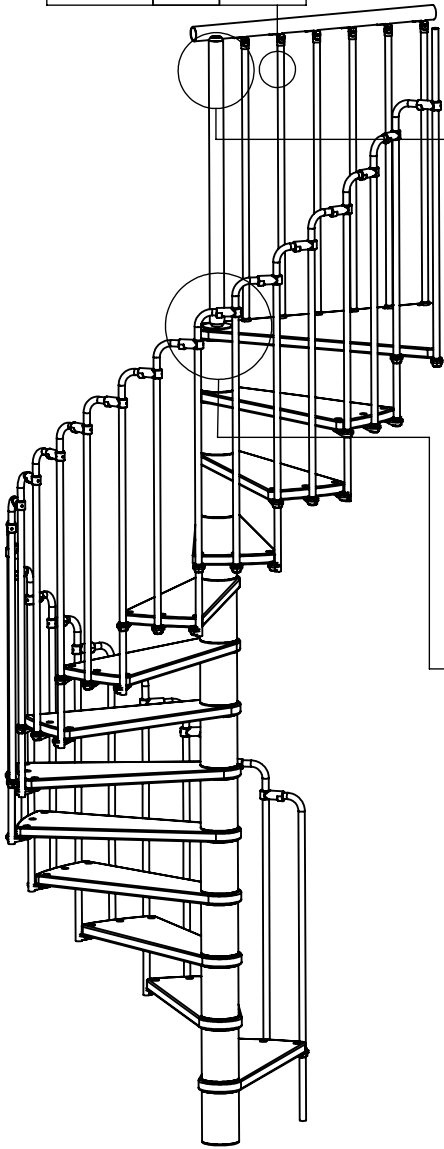
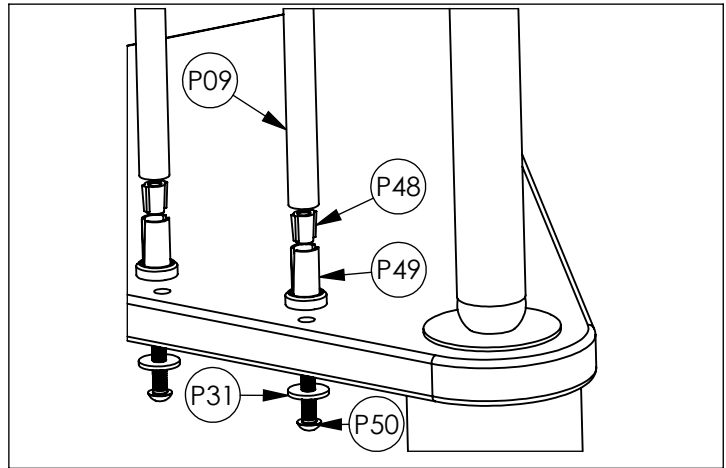
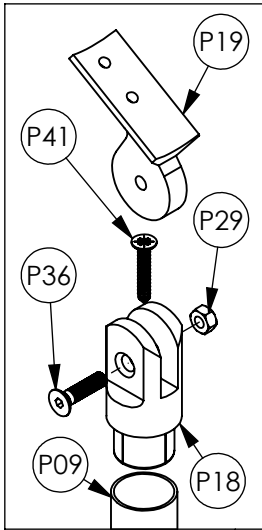

7

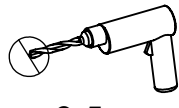
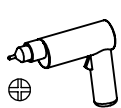

8,5 mm

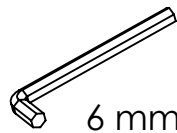
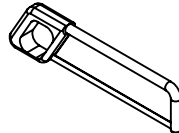

6 mm

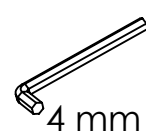

4 mm

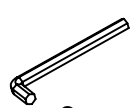

3 mm

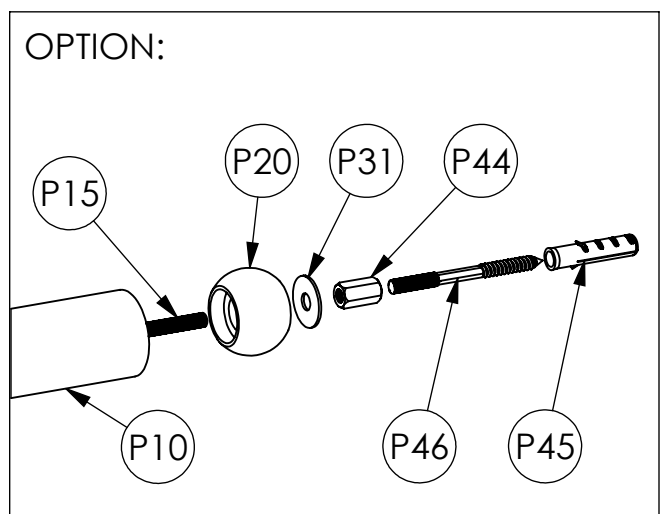
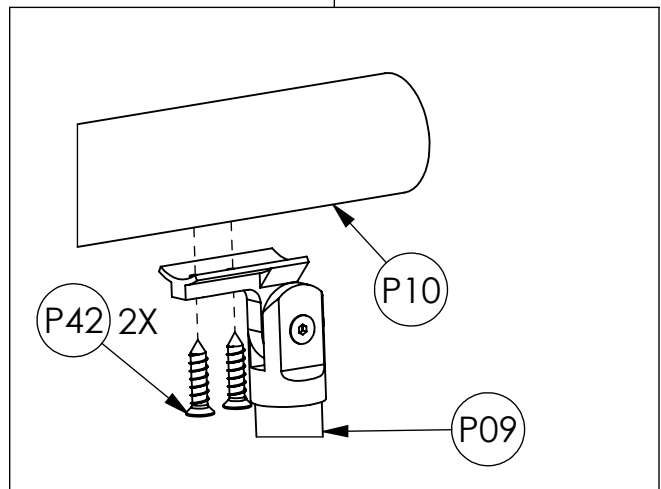
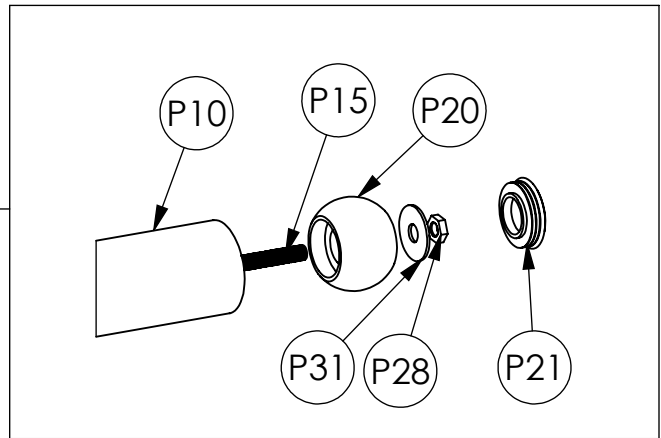
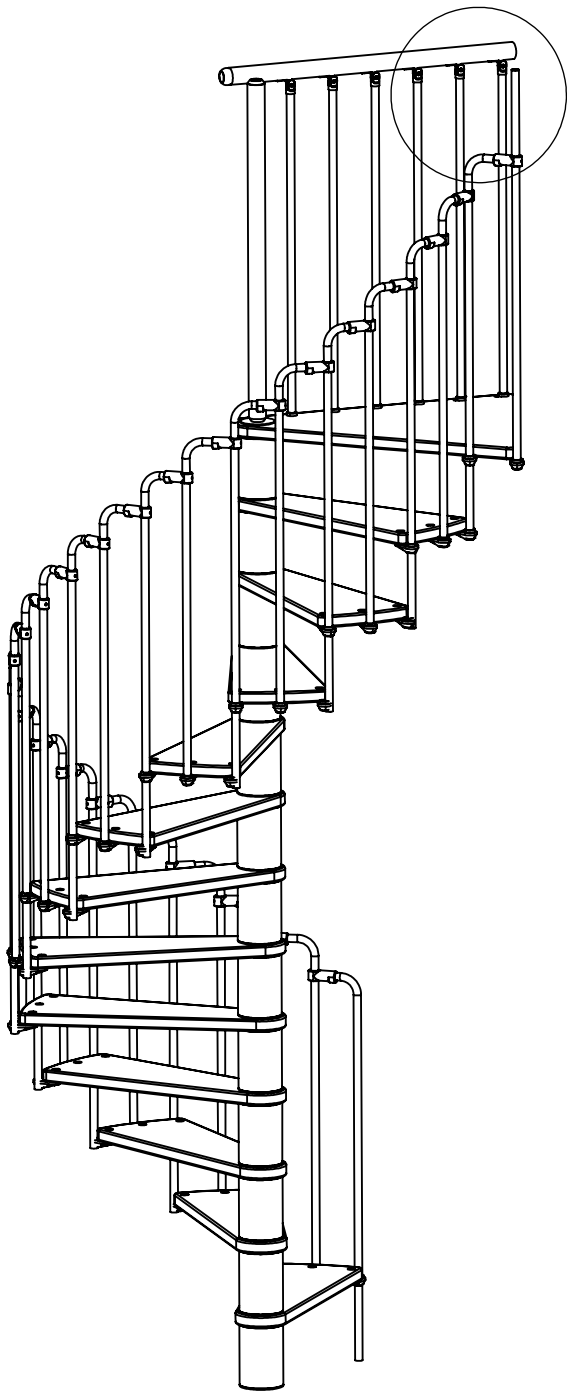

8

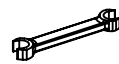
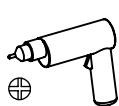

13 mm

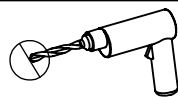

12 mm